

The Tata Power Company Ltd		OPEN TENDER NOTIFICATION
Tender Reference: CC24VJS065		Document Date: 20th Jan 2024

The Tata Power Company Limited Invites Tender through E-Tender Two-Part Bidding Process from interested bidders for the following package: -

A. Summary of the tendered package:

Sr. No.	Description	Tender Reference no.	Bid Guarantee Fee / EMD (Rs.)	Tender Fee (Rs.)	Last Date and Time for payment of Tender Participation fee
For the following package please send mail to Mr. Vinayak Shinde (vinayak.shinde@tatapower.com) with copy to Mr. Rameshkumar P N (pnramesh@tatapower.com)					
1.	Corrigendum to Tender issued vide published advertisement dtd. 19th Jan 2024 - Outline Agreement for supply of LT Panels for Mumbai Distribution	CC24VJS065	2,50,000/-	2,000 /-	31st Jan 2024

B. Procedure to Participate in Tender.

Following steps to be done before “Last date and time for Payment of Tender Participation Fee” as mentioned above

1. Non-Refundable Tender Fee, as indicated in table above, to be submitted in the form of Direct deposit in the following bank account and submit the receipt along with a covering letter clearly indicating the Tender Reference number –

Beneficiary Name – The Tata Power Co. Ltd.

Bank Name – HDFC Bank Ltd.

Branch Name – Fort Branch, Mumbai

Address – Maneckji Wadia Building, Nanik Motwani Marg, Fort, Mumbai 400023.

Branch Code – 60

Bank & Branch Code – 400240015

Account No – 00600110000763

Account type – CC

IFSC Code – HDFC0000060

2. Eligible and Interested Bidders to submit duly signed and stamped letter on Bidder's letterhead indicating

Tender Enquiry number

Name of authorized person

Contact number

e-mail id

Details of submission of Tender Participation Fee

The Tata Power Company Ltd		<i>OPEN TENDER NOTIFICATION</i>
<i>Tender Reference: CC24VJS065</i>		<i>Document Date: 20th Jan 2024</i>

E-mail with necessary attachment of 1 and 2 above to be send to vinayak.shinde@tatapower.com with copy to pnramesh@tatapower.com before “Last date and time for Payment of Tender Participation Fee”

Interested bidders to submit Tender Participation Fee and Authorization Letter before Last date and time as indicated above after which link from Tata Power E-Tender system (Ariba) will be shared for further communication and bid submission.

Please note all future correspondence regarding the tender, bid submission, bid submission date extension, Pre-bid query etc. will happen only through Tata Power E-Tender system (Ariba).

No e-mail or verbal correspondence will be responded. All communication will be done strictly with the bidder who have done the above step to participate in the Tender.

Also it may be strictly noted that once date of “Last date and time for Payment of Tender Participation Fee” is lapsed no Bidder will be sent link from Tata Power E-Tender System (Ariba). Without this link vendor will not be able to participate in the tender. Any last moment request to participate in tender will not be entertained.

Any payment of Tender Participation Fee by Bidder who have not done the pre-requisite will not be refunded.

Also all future corrigendum's to the said tender will be informed on Tender section on website <https://www.tatapower.com> only.

Summary of Changes

1. Date extension of submission of Expression of Interest till 31st Jan. 2024.

The original tender document is reproduced below.

The Tata Power Company Ltd		<i>OPEN TENDER NOTIFICATION</i>
<i>Tender Reference: CC24VJS065</i>		<i>Document Date: 20th Jan 2024</i>

OPEN TENDER NOTIFICATION

FOR

**Outline Agreement for supply of LT Panels for Mumbai
Distribution**

**The Tata Power Company Limited (Tata Power)
Smart Center of Procurement Excellence, 2nd Floor,
Sahar Receiving Station, Near Hotel Leela,
Sahar Airport Road, Andheri East, Mumbai-400059**

The Tata Power Company Ltd		<i>OPEN TENDER NOTIFICATION</i>
<i>Tender Reference: CC24VJS065</i>		<i>Document Date: 20th Jan 2024</i>

Section A : Tender Notice including Instruction to Bidders

1. Tender Details

1.1 Key Tender Specific Details

Reference Number	CC24VJS065
Description	Outline Agreement for supply of LT Panels for Mumbai Distribution
Type of Tender	Out Line Agreement
Estimated Period	One Year
Tender Fee	Rs 2000/-
Earnest Money Deposit (EMD)	Rs 2,50,000/- Rs. Two Lakhs Fifty Thousand Only PLEASE NOT THAT IT IS MANDATORY TO SUBMIT EMD IN BANK GUARANTEE FORMAT ONLY
Price Basis	On Firm Basis
Executive Handling this Tender*	Name: Mr. Vinayak Shinde E-Mail ID: vinayak.shinde@tatapower.com
Technical Query *	Name: Mr. Ajay Potdar E-Mail ID: avpotdar@tatapower.com

*You may contact the above personnel from Monday to Friday during office hours only.

The Tata Power Company Ltd		<i>OPEN TENDER NOTIFICATION</i>
<i>Tender Reference: CC24VJS065</i>		<i>Document Date: 20th Jan 2024</i>

1.2 Calendar of Events

(a)	Payment of Tender Fee and Submission of letter nominating authorized person by Interested Bidder indicating their intent to Buy Tender	Till 29 th January 2024
(b)	Access to Tender Documents through E-Tender system to authorized person of Interested Bidder	29 th January 2024
(c)	Last Date of receipt of pre-bid queries, if any.	By 5 th February 2024
(d)	Last Date of Posting Consolidated replies to all the pre-bid queries as received	10 th February 2024
(e)	Last date and time of receipt of Bids	19 th February 2024

Note:- * These date and time are as planned and tentative. In case of change the same shall be intimated to Authorized Person of Interested Bidder through E-Tender System.

Please note post submission of Bids relevant communication will be done with Authorized Person of Interested Bidder through E-Tender System

1.3 Mandatory documents required along with the Bid

- 1.3.1 Bid Guarantee Fee (EMD) of requisite value and validity. PLEASE NOTE THAT BID GUARANTEE ONLY IN FORM OF BANK GUARANTEE WILL BE ACCEPTED.
- 1.3.2 Requisite Documents to ascertain fulfilling of Technical and Commercial Pre-Qualification Requirement as detailed in Tender Enquiry.
- 1.3.3 Technical Submission including Drawings, Type Test details etc as detailed in Technical Specification.
- 1.3.4 Required Commercial Submission as detailed in Tender Document
- 1.3.5 Technical and Commercial Clarification and Deviations as per the format attached in the Tender Enquiry
- 1.3.6 Proper authorization letter to sign the tender and participate in Tata Power E-Tender system on the behalf of bidder.
- 1.3.7 **For vendor not registered with Tata Power, Duly filled Vendor Registration form with all supporting documents is mandatory to participate in the Tender.**

Please note that in absence of any of the above documents, the bid submitted by a bidder shall be liable for rejection.

Also please note that whenever editable format are shared it is requested that data be filled in relevant cells. No formatting or addition / deletion of rows / columns to be done. Wherever editable Excel submission are requested the file should be free from references, macros etc.

The Tata Power Company Ltd		<i>OPEN TENDER NOTIFICATION</i>
<i>Tender Reference: CC24VJS065</i>		<i>Document Date: 20th Jan 2024</i>

Checklist of Document Submission

Stage of Tendering	Document	Type of Format	Mode of submission
Before last date of Pre-Bid Query	Query / Clarification / Deviation (QCD) Format. (F1) Technical and Commercial	Editable Excel Format	Through message in E-tender system
Bid Submission Envelope 1 (First Part)	Earnest Money Deposit	Original Bank Guarantee	In Sealed Envelope
Bid Submission Envelope 2 (Second Part)	Documents to be uploaded in Ariba only. In case of multiple files, a zipped folder can be attached for the same (size limit of 100MB per zipped file)		
To be submitted Under Tab 2.1 in Ariba	Duly filled PQR and supporting documents		
	Duly filled PQR format	Editable Excel Format	E-Tender System
	Backup documents for Technical and Commercial PQR	Signed and Scanned documents	E-Tender System
To be submitted under Tab 2.2 in Ariba	Technical Submission and Supporting Documents		
	Duly filled Unpriced Bid Format. Signed copy of Technical Specifications indicating your acceptance of the same	Signed and scanned copy of document	E-Tender System
To be submitted under Tab 2.3 in Ariba	Commercial Submission and supporting document		

The Tata Power Company Ltd		<i>OPEN TENDER NOTIFICATION</i>
<i>Tender Reference: CC24VJS065</i>		<i>Document Date: 20th Jan 2024</i>

	Letter of Undertaking (FOR VENDORS NOT REGISTERED WITH TATA POWER)	Scanned Copy of letter of undertaking duly filled, stamped and signed	E-Tender System
	E-auction Undertaking form	Scanned Copy of letter of undertaking duly filled, stamped and signed	E-Tender System
Bid Submission Envelope 3 (Third Part)	Duly filled Priced Bid Format	Hard copy in original duly signed and stamped	Sealed Envelope
	Duly filled Priced Bid Format	To be entered in E-Tender System	E-Tender System

1.4 Deviation from Tender

Normally, the deviations to tender terms are not admissible and the bids with deviation are liable for rejection. Hence, the bidders are advised to refrain from taking any deviations on this Tender. Still in case of any deviations, all such deviations shall be set out by the Bidders, clause by clause in the Query / Clarification / Deviation (QCD) Format. Deviations have to be mandatorily submitted in editable Excel sheet.

Technical or Commercial Deviation should be mentioned in Deviation Format only. Deviation in any other document or Format will not be considered.

1.5 Right of Acceptance/Rejection

1.5.1 Bids are liable for rejection in absence of following:-

1.5.2 Mandatory Documents as listed in 1.3 above

1.5.3 Price Bid as per the Price Schedule mentioned in Tender Document

1.5.4 Receipt of Bid and Response to queries within the due date and time

Tata Power reserves the right to accept/reject any or all the bids without assigning any reason thereof.

The Tata Power Company Ltd		<i>OPEN TENDER NOTIFICATION</i>
<i>Tender Reference: CC24VJS065</i>		<i>Document Date: 20th Jan 2024</i>

1.6 Qualification Criteria

Sr no	Parameter	Tata Power Requirement	Documents required
1	Infrastructure	Bidder must be an OEM of Equipment with manufacturing facility / assembly in India. The bidder must have in-house routine and acceptance testing facilities for acceptance as per relevant IS/IEC	Self-undertaking to be submitted in this regard. TATA Power reserves the right to inspect the said manufacturing facility as a proof of compliance to this parameter.
2	Supply and Experience	The bidder must have supplied for same or higher size and voltage a) A minimum of 50 nos during last 3 years or b) A single order of 25 nos or c) Two orders of 15 nos last 3 years. Indian Subsidiaries of global companies having plant in India are also eligible to bid if the qualification requirements stated above are met independently or in combination with the parent company. Declaration from parent company needs to be submitted.	Purchase Order Copies and Completion Certificates. Self-undertaking to be submitted in this regard. TATA Power reserves the right to inspect the said manufacturing facility as a proof of compliance to this parameter.
3	Performance	The bidder should have performance certificates for 2 year satisfactory performance from at least 2 reputed Distribution Utilities for equipments of similar or higher rating. The work against these issued certificates should be completed in last seven years from the date of bid submission. In case the bidder has a previous association with any of Tata Power Groups for similar products and services, the performance feedback for that bidder by Tata Power User Group shall only be considered irrespective of performance certificates issued by any third organization.	Supply List & Performance Certificates from the utilities
4	Commercial Capability	Average Annual turnover of the bidder for last three years shall not be less than Rs 4 Crs	Copy of audited Balance Sheet and P&L Account to be submitted in this regard.

The Tata Power Company Ltd		<i>OPEN TENDER NOTIFICATION</i>
<i>Tender Reference: CC24VJS065</i>		<i>Document Date: 20th Jan 2024</i>

5	Type Test	<p>The bidder shall submit Type test reports obtained from NABL/ International Accredited Lab for the equipment / material offered. The type tests should have been conducted on the equipment / material of the same design.</p> <p>The type tests should have been conducted within 5 years prior to the date of bid opening. Time period for type test can be extended by another 5 years as a special case, if there is no change in design / material of construction (MOC).</p> <p>In case the type test reports furnished are not for the quoted equipment / material but for the equipment / material with higher voltage class and/or different capacity, then type test shall be carried out for the offered equipment / material from NABL / International Accredited Lab without any cost implication to the owner and the Type Test reports shall be submitted before dispatch of the equipment / material.</p>	<p>Type Test Report.</p> <p>Undertaking that there is no change in design / material of construction (MOC) if Type Test Report older than 5 years.</p> <p>Undertaking that type test shall be carried out for the offered equipment / material from NABL / International Accredited Lab without any cost implication to the owner and the Type Test reports shall be submitted before dispatch of the equipment / material, in case type test reports furnished are not for the quoted equipment / material but for the equipment / material with higher voltage class and/or different capacity, (if applicable)</p>
---	-----------	--	---

1.7 Pre-Bid Queries

Technical or Commercial Pre-Bid Queries if any has to be sent through message in E-Tender System. Pre-Bid Query has to be sent only in the Query / Clarification / Deviation (QCD) Format. Pre-Bid Queries sent in any other format or send through any other communication channel will not be accepted and answered. Pre-Bid Query have to be sent in the stipulated timeline as defined in the Tender Document. No Pre-Bid Query will be accepted after the due time and date as specified as "Last Date of receipt of pre-bid queries, if any"

1.8 Marketing Integrity

We have a fair and competitive marketplace. The rules for bidders are outlined in the General Condition of Contracts and other parts of Tender Documents. Bidders must agree to these rules prior to participating. In addition to other remedies available, Tata Power reserves the right to exclude a bidder from participating in future markets due to the bidder’s violation of any of the rules or obligations contained in the General Condition of Contracts or other part of the Tender Documents. A bidder who violates the market place rules or engages in behavior that disrupts the fair execution of the marketplace, may result in restriction of a bidder from further participation in the marketplace for a length of time, depending upon the seriousness of the violation. Examples of violations include, but are not limited to:

- Failure to honor prices submitted to the marketplace

The Tata Power Company Ltd		OPEN TENDER NOTIFICATION
Tender Reference: CC24VJS065		Document Date: 20th Jan 2024

- Breach of terms as published in TENDER
- Submit irrelevant documents or frequently cases of missing documents as part of compliance to Qualifying, Technical or Commercial Requirements causing unnecessary delay in Tender Evaluation

1.9 Supplier Confidentiality

All information contained in this tender is confidential and shall not be disclosed, published or advertised in any manner without written authorization from Tata Power. This includes all bidding information submitted to Tata Power. All tender documents remain the property of Tata Power and all suppliers are required to return these documents to Tata Power upon request. Suppliers who do not honor these confidentiality provisions will be excluded from participating in future bidding events.

1.10 Payment Terms

100% payment shall be made within **60 days** from the receipt and acceptance of the material at the Consignee Stores/Site/Location as per the Contractual Terms and Conditions.

2. Evaluation Criteria

- The bids will be evaluated technically on the compliance to tender terms and conditions.
- The bids will be evaluated commercially on the overall all-inclusive lowest cost for the complete tender BOQ/ each line item as calculated in Schedule of Items. Tata Power however, reserves right to split the order line item wise and/or quantity wise among more than one Bidder. Hence all bidders are advised to quote their most competitive rates against each line item.
- Bidder has to mandatorily quote against each item of Schedule of Items. Failing to do so, Tata Power may reject the bids.

NOTE: In case of a new bidder not registered with Tata Power, factory inspection and evaluation shall be carried out to ascertain bidder’s manufacturing capability and quality procedures. However Tata Power reserves the right to carry out factory inspection and evaluation for any bidder prior to technical qualification. In case a bidder is found as Disqualified in the factory evaluation, their bid shall not be evaluated any further and shall be summarily rejected. The decision of Tata Power shall be final and binding on the bidder in this regard.

2.1 Price Variation Clause and Cap: Not Applicable (On Firm basis)

3. Submission of Bid Documents

3.1 Bid Submission

Bidders are requested to submit their offer in line with this Tender document. Bids shall be submitted in 3 (three) parts:

FIRST PART: “EMD – BANK GUARANTEE” of Value detailed in 1.1 valid for 180 days from the due date of bid submission in the form of Bank Guarantee favoring ‘The Tata Power Company Limited’. The EMD has to be strictly in the format as mentioned in Tender Document, failing which it shall not be accepted by Tata Power and the bid as submitted shall be liable for rejection.

The Tata Power Company Ltd		OPEN TENDER NOTIFICATION
Tender Reference: CC24VJS065		Document Date: 20th Jan 2024

Note : BG of 180 days and further claim period of 180 days is needed. In case the same cannot be issued by your bank then BG valid for 365 days can be provided.

Tata Power Bank details for EMD BG / NEFT:

Beneficiary Name – The Tata Power Co. Ltd.

Bank Name – HDFC Bank Ltd.

Branch Name – Fort Branch, Mumbai

Address – Maneckji Wadia Building, Nanik Motwani Marg, Fort, Mumbai 400023.

Branch Code – 60

Bank & Branch Code – 400240015

Account No – 00600110000763

Account type – CC

IFSC Code – HDFC0000060

The hard copy of EMD in a sealed envelope should be sent on address mentioned in Tender document. Pls mail the UTR details in case of NEFT for verification.

First Part has to be submitted in Sealed Envelope.

SECOND PART: “TECHNICAL / UN-PRICED COMMERCIAL BID” shall contain the following documents:

- a) Documentary evidence in support of Technical, Commercial qualifying criteria
- b) Technical literature/GTP/Type test report/Details of Qualified Manpower Available/ Testing Facility available etc. *(complete in all respect as desired and detailed in Technical Specification and Technical Requirement Section)*
- c) Duly filled Technical and Commercial Deviation Sheets
- d) Duly filled formats like Authorization affidavit form
- e) *Unpriced Commercial Bid*

The technical / un-priced commercial bid shall be properly indexed and is to be submitted in Soft Copy though E-Tender system of Tata Power. Hard Copy of Technical Bids need not be submitted.

Second Part has to be submitted through E-Tender System Only

THIRD PART: “PRICE BID” shall contain only the price details and strictly in Price Bid format along with explicit break up of basic prices and applicable GST. Basic price should include packaging forwarding, freight, transit insurance and any other cost envisaged by the bidder.

Third part has to be submitted through E-Tender System (ARIBA) only.

FOR BIDS INVITED THROUGH E-TENDER SYSTEM (TECHNICAL AND UN-PRICED COMMERCIAL BID) :

In response to advertisement Bidder has to provide details of person authorized to Bid on behalf of the Bidder. An e-mail will be generated by E-Tender System and the authorized person can download the Tender Documents from the system.

SECOND and THIRD PART of the Bid have to be submitted in E-Tender System.

The Tata Power Company Ltd		<i>OPEN TENDER NOTIFICATION</i>
<i>Tender Reference: CC24VJS065</i>		<i>Document Date: 20th Jan 2024</i>

Bidders have to mandatorily submit SECOND PART (Technical and Un-priced commercial Bid) only through E-Tender system of Tata Power. Bids submitted through any other form/ route shall not be admissible.

EMD BG to be sent in a sealed envelope which shall be clearly marked as below to the below address.

EMD

“Please mention Tender Reference No”

The Tata Power Company Limited, Smart Center of Procurement Excellence, 2nd Floor, Sahar Receiving Station, Near Hotel Leela, Sahar Airport Road, Andheri East, Mumbai-400059

Bids submitted by Email/Telex/Telegram /Fax will be rejected. No request from any Bidder to Tata Power to collect the proposals from Courier/Airlines/Cargo Agents etc. shall be entertained.

SIGNING OF BID DOCUMENTS:

The bid must contain the name, residence and place of business of the person or persons making the bid and must be signed and sealed by the Bidder with his usual signature. The names of all persons signing should also be typed or printed below the signature.

The Bid being submitted must be signed by a person holding a Power of Attorney authorizing him to do so, certified copies of which shall be enclosed.

The Bid submitted on behalf of companies registered with the Indian Companies Act, for the time being in force, shall be signed by persons duly authorized to submit the Bid on behalf of the Company and shall be accompanied by certified true copies of the resolutions, extracts of Articles of Association, special or general Power of Attorney etc. to show clearly the title, authority and designation of persons signing the Bid on behalf of the Company. Satisfactory evidence of authority of the person signing on behalf of the Bidder shall be furnished with the bid.

A bid by a person who affixes to his signature the word ‘President’, ‘Managing Director’, ‘Secretary’, ‘Agent’ or other designation without disclosing his principal will be rejected.

The Bidder’s name stated on the Proposal shall be the exact legal name of the firm.

3.2 Contact Information

Communication Details: Detailed in 1.1

3.3 Bid Prices

Bidders shall quote for the entire Scope of Supply/ work with a break up of prices for individual items and Taxes & duties. The bidder shall complete the appropriate Price Schedules included herein, stating the Unit Price for each item & total price with taxes, duties & freight up to destination at various sites of Tata Power. The all-inclusive prices offered shall be inclusive of all costs as well as Duties, Taxes and Levies paid or payable during the execution of the supply work, breakup of price constituents.

The quantity break up shown else-where other than Price Schedule is tentative. The bidder shall ascertain himself regarding material required for completeness of the entire work. Any items not indicated in the price schedule but which are required to complete the job as per the Technical Specifications/ Scope of Work/ SLA mentioned in the tender, shall be deemed to be included in prices quoted.

The Tata Power Company Ltd		<i>OPEN TENDER NOTIFICATION</i>
<i>Tender Reference: CC24VJS065</i>		<i>Document Date: 20th Jan 2024</i>

3.4 Bid Currencies

Prices shall be quoted in Indian Rupees Only. It also may be noted that the denomination of Purchase Order / Outline Agreement / Rate Contract and associated Payment to Successful Bidder shall also be in Indian Rupees Only. In case Bidder intends to import any equipment, part etc and supply to Tata Power then all liability and costs related to import will rest with the Bidder. All statutory compliances, payments, expenditure etc related to importing of equipment will be responsibility of the bidder.

3.5 Period of Validity of Bids

Bids shall remain valid for 180 days from the due date of submission of the bid.

Notwithstanding clause above, Tata Power may solicit the Bidder's consent to an extension of the Period of Bid Validity. The request and responses thereto shall be made in writing.

3.6 Alternative Bids

Bidders shall submit Bids, which comply with the Bidding documents. Alternative bids will not be considered. The attention of Bidders is drawn to the provisions regarding the rejection of Bids in the terms and conditions, which are not substantially responsive to the requirements of the bidding documents.

3.7 Modifications and Withdrawal of Bids

The bidder is not allowed to modify or withdraw its bid after the Bid's submission. The EMD as submitted along with the bid shall be liable for forfeiture in such event.

3.8 Earnest Money Deposit (EMD)

The bidder shall furnish, as part of its bid, an EMD amounting as specified in the tender. The EMD is required to protect the Tata Power against the risk of bidder's conduct which would warrant forfeiture.

The EMD shall be in following form:

- Bank Guarantee valid for 180 days after due date of submission.

The EMD shall be forfeited in case of:

- a) The bidder withdraws its bid during the period of specified bid validity.

Or

- b) In case of a successful bidder, if the Bidder, within 15 days, does not
 - i) accept the purchase order, or
 - ii) furnish the required Contract Performance Bank Guarantee (CPBG)

Original Bank Guarantee submitted as EMD shall be returned only after completion of award process for unsuccessful bidders and issue of Contract Performance Bank Guarantee (CPBG) for successful bidder.

4. Bid Opening & Evaluation process

4.1 Process to be confidential

Information relating to the examination, clarification, evaluation and comparison of Bids and recommendations for the award of a contract shall not be disclosed to Bidders or any other persons

The Tata Power Company Ltd		<i>OPEN TENDER NOTIFICATION</i>
<i>Tender Reference: CC24VJS065</i>		<i>Document Date: 20th Jan 2024</i>

not officially concerned with such process. Any effort by a Bidder to influence Tata Powers processing of Bids or award decisions may result in the rejection of the Bidder's Bid.

4.2 Technical Bid Opening

Bids will be opened at Corporate Office of Tata Power as per our standard Process. The bids shall be opened internally by Tata Power. Technical bid must not contain any cost information whatsoever.

First the envelope marked “EMD” will be opened. Bids without EMD of required amount/ validity in prescribed format, shall be rejected.

Next, the technical bid of the bidders who have furnished the requisite EMD will be opened in E-Tender system.

4.3 Preliminary Examination of Bids/Responsiveness

Tata Power will examine the Bids to determine whether they are complete, whether any computational errors have been made, whether required sureties have been furnished, whether the documents have been properly signed, and whether the Bids are generally in order. Tata Power may ask for submission of original documents in order to verify the documents submitted in support of qualification criteria.

Prior to the detailed evaluation, Tata Power will determine the substantial responsiveness of each Bid to the Bidding Documents including production capability and acceptable quality of the Goods offered. A substantially responsive Bid is one, which conforms to all the terms and conditions of the Bidding Documents without material deviation.

Bid determined as not substantially responsive will be rejected by the Tata Power and/or the Tata Power and may not subsequently be made responsive by the Bidder by correction of the non-conformity.

4.4 Techno Commercial Clarifications

Bidders need to ensure that the bids submitted by them are complete in all respects. To assist in the examination, evaluation and comparison of Bids, Tata Power may, at its discretion, ask the Bidder for a clarification on its Bid for any deviations with respect to the Tata Power specifications and attempt will be made to bring all bids on a common footing. All responses to requests for clarification shall be in writing and no change in the price or substance of the Bid shall be sought, offered or permitted owing to any clarifications sought by Tata Power.

4.5 Price Bid Opening

The EMD of the bidder withdrawing or substantially altering his offer at any stage after the technical bid opening will be forfeited at the sole discretion of Tata Power without any further correspondence in this regard.

Arithmetical errors will be rectified on the following basis: If there is a discrepancy between the unit price and the total price per item that is obtained by multiplying the unit price and quantity, the unit price shall prevail and the total price per item will be corrected. If there is a discrepancy between the Total Amount and the sum of the total price per item, the sum of the total price per item shall prevail and the Total Amount will be corrected.

The Tata Power Company Ltd		OPEN TENDER NOTIFICATION
Tender Reference: CC24VJS065		Document Date: 20th Jan 2024

4.6 Reverse Auction and Price Matching Option

Tata Power reserves the right to go for Reverse Auction (RA) for price negotiation and discover the most competitive price on ARIBA portal, Tata Power’s official e-tendering platform. This will be decided after techno-commercial evaluation of the bids. Bidders need to give their acceptance with the offer for participation in RA. Non-acceptance to participate in RA may result in non-consideration of their bids, in case Tata Power decides to go for RA.

Only those bidders who are techno-commercially qualified shall be eligible to participate further in RA process. However, the original H1 bidder (whose price bid is the highest post techno-commercial evaluation) shall not be allowed to participate in further RA process provided minimum three techno-commercially qualified bids are available.

For case where more than one bidders have to be awarded (including Rate Contract / Outline Agreement) Price Matching Option will be exercised. Volume of job allocated to original competitive bidder will be more than bidder who is chosen through Price Matching Option. Tata Power decision regarding work sharing shall be final and no explanation OR clarification shall be given regarding the same.

5.0 Award Decision

Tata Power will award the contract to the successful bidder whose bid has been determined to be the lowest-evaluated responsive bid as per the Evaluation Criterion mentioned at Clause 2.0. The Cost for the said calculation shall be taken as the all-inclusive cost quoted by bidder in Priced Bid Format subject to any corrections required in line with Clause 4.3 above. The decision to place purchase order/Outline Agreement/ Rate Contract solely depends on Tata Power on the cost competitiveness across multiple lots, quality, delivery and bidder’s capacity, in addition to other factors that Tata Power may deem relevant.

Tata Power reserves all the rights to award the contract to one or more bidders so as to meet the delivery requirement or nullify the award decision without assigning any reason thereof.

In case any supplier is found unsatisfactory during the delivery process, the award will be cancelled and Tata Power reserves the right to award other suppliers who are found fit.

5.1 Rate Contract / Outline Agreement

Rate Contract / Outline Agreement does not guarantee any assured business volume in Rupees or Quantity. Quantities are only indicative and specified for the purpose of readiness as per the request from Purchaser. Supplies shall be only against Firm Purchase Orders placed as per the agreed terms and conditions of Rate Contract / Outline Agreement. Purchaser shall be entitled at its discretion to place firm order for such supplies on "As and When Required Basis" without minimum take-off guarantee.

Rate Contract / Outline Agreement will have list of Items with Unit Rate and applicable Taxes and Duties. There will be a cap on value for which order which can be placed against the Rate Contract / Outline Agreement. Actual quantity ordered for each line item may differ significantly from the tentative quantity indicated in the Tender Document. One / few / all items of Rate Contract / Outline Agreement can be ordered till the Cap Value is reached.

The Tata Power Company Ltd		<i>OPEN TENDER NOTIFICATION</i>
<i>Tender Reference: CC24VJS065</i>		<i>Document Date: 20th Jan 2024</i>

6.0 Order of Preference/Contradiction:

In case of contradiction in any part of various documents in tender, following shall prevail in order of preference:

1. Outline Agreement/Purchase Order (with Commercial conditions)
2. Special Terms and conditions (if applicable)
3. General Terms and conditions
4. Technical Specifications

In case there is a discrepancy in the BOQ mentioned in tender (to the extent modified through subsequent Corrigendum, if any) and the bid submitted by any bidder, the description as mentioned in the tender (to the extent modified through subsequent Corrigendum, if any) shall prevail.

7.0 Ethics

Tata Power is an ethical organization and as a policy Tata Power lays emphasis on ethical practices across its entire domain. Bidder should ensure that they should abide by all the ethical norms and in no form either directly or indirectly be involved in unethical practice.

Tata Power work practices are governed by the Tata Code of Conduct. Bidder is request to refer Tata Code of Conduct Clause in General Terms and Conditions.

8.0 General Condition of Contract and Special Condition of Contracts

Any condition not mentioned above shall be applicable as per General Terms and Conditions and Special Condition of Contracts attached along with this tender.

---XXX---

The Tata Power Company Ltd		<i>OPEN TENDER NOTIFICATION</i>
<i>Tender Reference: CC24VJS065</i>		<i>Document Date: 20th Jan 2024</i>

Annexure 1
Schedule Of Items

Sr. no.	Material / Service Short Text (as per SAP)	Quantity	UoM	Unit Rate (Basic)	Total
1	LTP 3200A, 415V, 8W-800A O/G FUSE	3	nos.		-
2	LTP 2000A, 415V, 6W-630A O/G FUSE	89	nos.		-
3	LTP 1250A, 415V, 6W-630A O/G FUSE	15	nos.		-
4	LTP 2500A, 415V, 2MCCB & 3Fuse	3	nos.		-
5	LTP 3200A,2-1200A MCCB,2-630A&2-800 FUSE	4	nos.		-
6	LTP 2500A, 415V, 6W-630A O/G FUSE	15	nos.		-
7	LTP 2500A, 415V, 8W-630A O/G FUSE	15	nos.		-
8	Type test Charges (Temp rise on LV panels) - LT	1	nos.		-
	Sub Total				-
	GST @18%				-
	Total with taxes				-

TECHNICAL SPECIFICATION

2500 A LT Panel with MCCB & Fuse



The Tata Power Company Ltd.
Engineering Services (ENSE),
Distribution Division,
Senapati Bapat Marg,
Lower Parel,
Mumbai – 400013
Maharashtra

The Tata Power Company Limited		TECHNICAL SPECIFICATION OF 2500 A LT Panel with MCCB & Fuse
ENSE-DS-2028-R00		Date of Issue: 11/01/2024

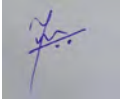

TECHNICAL SPECIFICATION COVER SHEET

Document No: ENSE-DS-2028-R00

Document Title: Technical SPECIFICATION OF 2500 A LT Panels with MCCB & Fuse

R00	ENSE-DS-2028-R00 (For Tendering Purpose)	11/01/2024	YMM		AVP		RMB	
R0	D-NPCE-SPEC-07	21/08/2019	ND	-sd-	NK	-sd-	NCP	-sd-
Rev No.	Remarks	Date	Initials	Sign	Initials	Sign	Initials	Sign
			Prepared By		Reviewed By		Approved & Issued By	

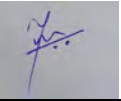

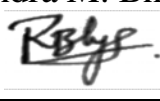
TATA POWER

Rev No.	Prepared By & Date	Checked By & Date	Approved for Issue By & Date
R00	Yash M. Mane 	Ajay V. Potdar 	Ravindra M. Bhanage 
	11/01/2024	11/01/2024	11/01/2024



The Tata Power Company Limited		TECHNICAL SPECIFICATION OF 2500 A LT Panel with MCCB & Fuse
ENSE-DS-2028-R00		Date of Issue: 11/01/2024

CONTENTS

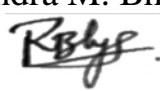
	<u>PAGE NO</u>
1.0 SCOPE	4
2.0 APPLICABLE STANDARDS	4
3.0 CLIMATIC CONDITIONS OF THE INSTALLATION	5
4.0 GENERAL TECHNICAL REQUIREMENTS	5
5.0 GENERAL CONSTRUCTIONS	9
6.0 NAME PLATE & MARKINGS	15
7.0 TESTS, ROUTINE & ACCEPTANCE TESTS	15
8.0 TYPE TEST CERIFICATES	16
9.0 PRE-DISPATCH INSPECTION	16
10.0 INSPECTION AFTER RECEIPT AT STORE	17
11.0 GUARANTEE	17
12.0 PACKING AND TRANSPORT	17
13.0 TENDER SAMPLE	17
14.0 QUALITY CONTROL	18
15.0 MINIMUM TESTING FACILITIES	18
16.0 MANUFACTURING ACTIVITIES	18
17.0 SPARES, ACCESSORIES AND TOOLS	18
18.0 DRAWING AND DOCUMENTS	18
19.0 SCHEDULE "A" GUARANTEED TECHNICAL PARTICULARS	18
20.0 SCHEDULE "B" DEVIATIONS	19
+ ANNEXURE 1, 2 & 3	

Rev No.	Prepared By & Date	Checked By & Date	Approved for Issue By & Date
R00	Yash M. Mane 	Ajay V. Potdar 	Ravindra M. Bhanage 
	11/01/2024	11/01/2024	11/01/2024

1.0	SCOPE	<p>This specification covers design, engineering, manufacture; shop testing, inspection, painting, packing, and supply of 415V, 2500 A LT Panel with 2 no's 3P 1000 A MCCB & 3 nos 800 A HRC Fuse Outgoing Feeders complete with all accessories for efficient and trouble-free operation of the distribution network for Tata Power Company Limited at Mumbai.</p> <p>It is not our intent to specify completely herein all details of design and construction of the equipment. However, the equipment shall conform in all respects to high standards of Engineering design and workmanship and shall be capable of performing in a manner acceptable to the purchaser (TPC) who will interpret the meaning of drawings and specification and shall be entitled to reject any work or material which in his judgement is not in full accordance therewith.</p> <p>All the bought-out items shall be of reputed make and shall be subject to approval by the PURCHASER (TPC) after award of contract.</p>																																				
2.0	APPLICABLE STANDARDS	<p>The equipment shall conform to this specification and latest revision of following codes with all amendments.</p> <table border="1" data-bbox="427 925 1481 1675"> <thead> <tr> <th></th> <th>Title</th> <th>Indian standard</th> </tr> </thead> <tbody> <tr> <td>1</td> <td>IS 8623</td> <td>Specification for low voltage switchgear</td> </tr> <tr> <td>2</td> <td>IS 12063/ IEC 60529</td> <td>Classification of degrees of protection provided by Enclosures of Electrical equipment</td> </tr> <tr> <td>3</td> <td>IS 5</td> <td>Color of ready mixed paints</td> </tr> <tr> <td>4</td> <td>IS 5082</td> <td>Wrought Aluminium & Al alloy plates & sheets for electrical application</td> </tr> <tr> <td>5</td> <td>IS 2705</td> <td>Current Transformers</td> </tr> <tr> <td>6</td> <td>IS 2551</td> <td>Danger Notice plates</td> </tr> <tr> <td>7</td> <td>IS 13703-2</td> <td>Low voltage fuses for voltage not exceeding 1000 V AC or 1500 V DC. Part 2 Fuses for use by authorized persons</td> </tr> <tr> <td>8</td> <td>IEC 255</td> <td>Protection Relays</td> </tr> <tr> <td>9</td> <td>IEC 801</td> <td>Control and monitoring</td> </tr> <tr> <td>10</td> <td>IEC 60947-2 /IS 13947-2</td> <td>Low Voltage Switchgear & control gear</td> </tr> <tr> <td>11</td> <td>IEC 60269</td> <td>Low Voltage Fuses</td> </tr> </tbody> </table> <p>In case of any conflict on any technical particular in the specification, the stricter requirement mentioned in the relevant standard shall be valid.</p>		Title	Indian standard	1	IS 8623	Specification for low voltage switchgear	2	IS 12063/ IEC 60529	Classification of degrees of protection provided by Enclosures of Electrical equipment	3	IS 5	Color of ready mixed paints	4	IS 5082	Wrought Aluminium & Al alloy plates & sheets for electrical application	5	IS 2705	Current Transformers	6	IS 2551	Danger Notice plates	7	IS 13703-2	Low voltage fuses for voltage not exceeding 1000 V AC or 1500 V DC. Part 2 Fuses for use by authorized persons	8	IEC 255	Protection Relays	9	IEC 801	Control and monitoring	10	IEC 60947-2 /IS 13947-2	Low Voltage Switchgear & control gear	11	IEC 60269	Low Voltage Fuses
	Title	Indian standard																																				
1	IS 8623	Specification for low voltage switchgear																																				
2	IS 12063/ IEC 60529	Classification of degrees of protection provided by Enclosures of Electrical equipment																																				
3	IS 5	Color of ready mixed paints																																				
4	IS 5082	Wrought Aluminium & Al alloy plates & sheets for electrical application																																				
5	IS 2705	Current Transformers																																				
6	IS 2551	Danger Notice plates																																				
7	IS 13703-2	Low voltage fuses for voltage not exceeding 1000 V AC or 1500 V DC. Part 2 Fuses for use by authorized persons																																				
8	IEC 255	Protection Relays																																				
9	IEC 801	Control and monitoring																																				
10	IEC 60947-2 /IS 13947-2	Low Voltage Switchgear & control gear																																				
11	IEC 60269	Low Voltage Fuses																																				

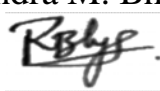
Rev No.	Prepared By & Date	Checked By & Date	Approved for Issue By & Date
R00	Yash M. Mane 	Ajay V. Potdar 	Ravindra M. Bhanage 
	11/01/2024	11/01/2024	11/01/2024

3.0

**CLIMATIC
CONDITIONS OF
THE
INSTALLATION**



1	Maximum ambient temperature	43 deg.C
2	Max. Daily average ambient temp	35 deg.C
3	Min Ambient Temperature	07 deg.C
4	Maximum Relative Humidity	100%
5	Minimum Relative Humidity	40%
6	Average No. of thunderstorm per annum	50
7	Average Annual Rainfall	2380mm
8	Average No. of rainy days per annum	115
9	Rainy months	June to Oct.
10	Altitude above MSL not exceeding	300 meters
11	Average Air Pressure	29.6-inch Hg

Atmosphere is generally laden with mild acid and dust suspended during dry months and subjected to fog in cold months. The design of the equipment and accessories shall be suitable to withstand seismic forces corresponding to an acceleration of 0.1g.



4.0

**GENERAL
TECHNICAL
REQUIREMENTS**

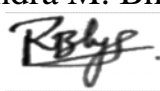

Sr. No	Item Description	Tata Power Requirement
1	Manufacturer	Name
		Manufacturer Address
		Contact telephone no
2	Breaker Rating (ACB)	2500A Manual Fixed Type without any microprocessor relay. 230V AC Shunt tripping coil to be provided.
	Model of ACB	The Model shall be such that current density in current carrying part shall be less than 3 A/sq.mm. (Bidder to mention the model)
	Approved Make	Schneider/ L&T/ Siemens/ C&S/ ABB/ Eaton
3	Main bus bar rating	2500 A
	Bus bar Size for Phase & Neutral	3600 sq.mm for Phase & Neutral
	Earth Bus	1 x 50 x 10 mm GI
4	Type of Installation	Indoor / Outdoor Type
5	No of Incoming feeders	Qty -1no. of 2500A ACB with 8 Nos of 4CX300 sq.mm Al Ar XLPE cables
6	No of outgoing feeders – 1000 A MCCB	Quantity - 2 Nos of 1000A each with 4 no's of 4CX300 sq.mm Al Ar XLPE cables per O/G

Rev No.	Prepared By & Date	Checked By & Date	Approved for Issue By & Date
R00	Yash M. Mane 	Ajay V. Potdar 	Ravindra M. Bhanage 
	11/01/2024	11/01/2024	11/01/2024

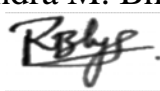

	No of outgoing feeders – HRC Fuse	Quantity - 3 Nos of 800A each With 3 no's of 4CX300 sq.mm Al Ar XLPE cables per O/G
7	Panel construction	CRCA sheet steel of thickness 3 mm
8	Panel enclosure class	IP54 - ingress protection
9	Sheet steel thickness	Doors & Covers - 2.5mm, FRAME - 3mm
10	Door type for front & rear access	Double door with rear door bolted
11	Door hinges	Minimum three anti-theft type hinges self-locking type
12	Padlocking facility	For front door
13	Master key for all doors	Identical for all panels, 1 no./ panel to be provided
14	Hardware & Fasteners	All Nuts, Bolts, Washers shall be Hot Dip Galvanized with 80 micron Galvanisation or Alu-Zinc coating. Bolts below 12 mm size shall be SS material.
14a	Current Carrying part hardware	Each bolt on Bus Bar and Fuse terminal shall be provided with Belleville washer and plain washer. Wherever required bimetallic washers to be provided
15	Phase & neutral Bus bar	Aluminium grade 19501 (H2) as per IS 5082
	Bus bar size in mm for 2500 A O/G	3600 sq.mm for Phase & Neutral
	2500A ACB Incoming	3600 sq.mm for Phase & Neutral
	ACB O/G LINKS	3600 sq.mm for Phase & Neutral (Dimensions as per feasibility with Breaker palm connection)
16	Bus bar colour coding for R, Y, B & neutral	Heat shrinkable sleeves with colour Red, Yellow, Blue & Black respectively
16 a	Bus Bar Heat shrinkable sleeves	Cross-linked Polyolefin (Bidder to specify thickness)
17	Main bus bar short circuit withstand capacity	Above 50kA for 1 sec
18	Permissible maximum temperature rise above ambient of 50°C	Busbar: 45 deg C
	Permissible maximum temperature rise above ambient of 50°C	Terminals: 65 deg C
19	Bus bar support insulators	As per IS13410 SMC / DMC, 1100V grade
20	Incoming Cable Size	4C 300 Sq.mm Al Ar XLPE
21	Outgoing Cable Size	4C 300 Sq.mm Al Ar XLPE

Rev No.	Prepared By & Date	Checked By & Date	Approved for Issue By & Date
R00	Yash M. Mane 	Ajay V. Potdar 	Ravindra M. Bhanage 
	11/01/2024	11/01/2024	11/01/2024

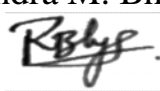
		22	Gland plate at panel bottom	HRCA MS 3mm thickness
		23	Cable termination clearance	600 mm minimum from gland plate & ACB
		24	Fuse Base	800 A
			Approved Make	L&T / Siemens / Schneider / GE Power Control / Jean Muller /Bussmann / ABB
		25	Fuses (800 A)	HRC plug-in type gG (General Purpose, Fast acting fuse)
			Approved Make	L&T / Siemens / Schneider / GE Power Control / Jean Muller /Bussmann / ABB
		26	1000 A MCCB 3P	MCCB shall be with Micro Processor Based Release having LSIG Protections. The MCCB shall have Spreader Links & Phase Barriers.
				Approved Make - Schneider/L&T/ABB/Siemens/Eaton
		27	CT's for 2500A Incoming Feeder	7 Nos. Single resin cast. a) 3 no's dual core CT's of ratio 2500/5A <ul style="list-style-type: none"> • Core 1: Class 0.5 & 15VA burden – For MFM • Core 2: 5P20 & 15VA – For Ashida make O/C+E/F relay b) 3 no's single core CTs of ratio 2500/5 A, Class 0.5 & 15 VA for Energy meter (Energy meter is not in bidder scope) c) 1 no single core CT of ratio 2500/5A, 5P20 & 15 VA for Neutral unbalance protection Approved Make of CTs: Reco/Newtek/Pragati/Kappa/ECS/Adcon
		28	TTB for Metering	Front connection, Screw Type 3 Phase 4 Wire, 4SF, 50 A, DAV/IMP make
		29	Wiring convention for TTB	Incoming from Bottom Side & Outgoing to Meter from Top side
		30	Multifunction Digital meter	Should be communicable on Modbus RS 485
		31	Earth Fault protection relay (NEF)	Alstom make CDG11 self-powered. Relay type is normal inverse with 3 Sec with E/F setting of 0.5 to 2 A
		32	Earthing Hardware	a) Earthing Nut and Bolt shall be M12 SS b) Washers shall be with Hot Dip Galvanized with 80 micron Galvanisation or Alu-Zinc coating.
32a	Panel Earthing	Earthing provision to be provided on both sides with 50 mm extension of main Earth Bus Bar.		
33	Clearance between live parts	Phase - phase -Minimum 25 mm & Phase - earth - Minimum 20 mm		

Rev No.	Prepared By & Date	Checked By & Date	Approved for Issue By & Date
R00	Yash M. Mane 	Ajay V. Potdar 	Ravindra M. Bhanage 
	11/01/2024	11/01/2024	11/01/2024

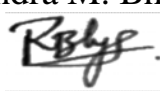

34	Distance between each fuse outlet	Centre to Centre - 150mm (Minimum)
35	Distance between fuse outlet & panel surface	125 mm (Minimum)
36	Distance between 2 MCCBs	80 mm (Minimum)
37	Distance between MCCB outlet & panel surface	125 mm (Minimum)
38	Control terminals for CTs	Stud type with disconnecting facilities
39	Control terminals for Voltage & other circuits	Stud type
40	Illumination and Indicating Bulb	LED
41	Continuous rated operating voltage	440 volt +/- 10%
42	High voltage withstand capacity	2000 volt at 50 Hz for 1minute
43	Insulation resistance ph-ph & ph-earth	Minimum 10MOhm with 500V Megger
44	Labels & name plates	As per Specifications
45	Surface preparation for painting	Sand blasting or 7 tank process
46	Painting	Sand blasting or 7 tank process. Light grey shade No 631 of IS-5 Powder coated epoxy paint min thickness 120 micron
47	Power Supply Socket	5A/15A Plug point socket to be provided
48	Breaker Barrier	Breaker must have a metallic removable sheet from the front side which will act as a barrier between operator and the breaker. Provision must be given for breaker operation to be done through this barrier.
49	Branding Plate	All supplied Units shall be fitted with engraved metallic logo of Tata Power on the front side. The Tata Power Co Ltd to be mentioned below the logo with clear font and Dimension 12*12 Inches. * Refer Annexure 2
50	Panel Dimensions (Min depth of 900 mm)	L X D X H
51	Numerical Relay	Ashida (ADR 241S) with 4 Element For E/F and O/C Protection on ACB.
52	Bus-bar phase barriers/ Phase separators (R-Y & Y-B)	FRP insulating sheet - (to be placed near to the phase bus-bar) (min 3 mm thickness) shall be provided between bus-bars, so as to ensure that there is no accidental contact with any live parts. (65 mm width)

Rev No.	Prepared By & Date	Checked By & Date	Approved for Issue By & Date
R00	Yash M. Mane 	Ajay V. Potdar 	Ravindra M. Bhanage 
	11/01/2024	11/01/2024	11/01/2024



5.0

**GENERAL
CONSTRUCTION**

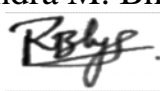
- 1) The feeder pillar frame shall be fabricated using suitable mild steel structural section or pressed and shaped Cold Rolled Closed Annealed (CRCA) sheet of thickness 3 mm.
- 2) Frames shall be enclosed by CRCA sheet of thickness 3mm, smoothly finished, levelled and free from flaws. Doors and cover shall be made of CRCA sheet of thickness not less than 2.5mm. Stiffeners shall be provided, wherever necessary. Gland plates shall be of Hot Rolled Closed Annealed (HRCA) thickness not less than 3 mm. alternatively gland can also be provided between two angles so that removal of gland is easy. The dimension of base frame should be 75mm X 40mm X 5 mm.
- 3) The panel shall be of metal enclosed and outdoor type, support frame mounted type with canopy of adequate slope to avoid water accumulation. Degree of protection shall be IP 54.
- 4) Breaker compartment and fuse compartment should be separated by metallic sheet; the same should be split suitably in order to avoid local heating due to eddy currents generated by three phase bus bars crossing through the same sheet. The breaker compartment should be in center of panel & Outgoings shall be on both the sides of breaker compartment.
- 5) The panel shall be of dust and vermin proof construction and of self-cooled design with adequate louvers on sides and top portion. The louvers shall have fine wire mesh made of brass. The minimum depth of panel shall be 900 mm.
- 6) Labels on the front and rear indicating the panel designation, phase marking and danger signs shall be provided. Single Line Diagram & feeder details shall be engraved and pasted on inside of panel.
- 7) Danger boards shall be provided in local languages on the Hylam sheet below breaker and on front & rear cover with red background and with white letters.
- 8) Hinged doors of lift off type, with concealed type with brass type hinges and captive screws shall be provided on the front side & Back side. Adequate numbers of door hinges shall be provided and should be durable and easy in operation. All doors shall be provided with padlocking facility. The design of doors should permit inter-changeability. The back-side doors shall have nut and bolt arrangement. All Hinged doors shall be connected to the earth terminal with 2.5 Sq.mm braided copper wires.
- 9) Cable entry facilities at bottom of panel and removable gland plates of size suitable to accommodate incoming & outgoing cables of sizes, 4 Core 300 Sq mm 1.1 KV XLPE Cable, shall be provided at required locations.
- 10) Distance between Gland plate and cable termination of Air Circuit Breaker should be minimum 600mm.
- 11) The panel shall be provided with gasket all around the perimeter of covers, gland plates, removable covers and doors.
- 12) ACB termination shall be with tinned copper or tinned aluminium Bus Bar. Wherever required bimetallic washer to be provide, if bare copper terminal is provided.

Rev No.	Prepared By & Date	Checked By & Date	Approved for Issue By & Date
R00	Yash M. Mane 	Ajay V. Potdar 	Ravindra M. Bhanage 
	11/01/2024	11/01/2024	11/01/2024

- 13) Busbars shall be of aluminium with Bakelite shrouding, rated for 2500A, 50 kA for 1 sec and shall have adequate cross section to carry the rated continuous and short time current. Main Bus bar should be continuous/ without any joint. All bus bars, bus taps and joints shall be PVC taped. Neutral bus bar shall be provided on read side & rated for full bus bar rating.
- 14) **The ACBs shall be mechanical operated fixed type 3 Pole with shunt trip coil without any microprocessor protection release. Ashida make (ADR41S) relay to be provided for tripping the breaker with Overcurrent & earth fault protection. Spare ACB contacts for shunt trip should be provided.**
- 15) All fuses shall be of the HRC cartridge type mounted on plug-in type fuse bases having a prospective current of not less than 80 kA.
- 16) MCCB shall be with Micro Processor Based Release having LSIG Protections. The MCCB shall have Spreader Links & Phase Barriers,
- 17) Phase to phase clearance of 25mm and Phase to Neutral / Earth clearance of 20mm shall be provided in the panel.
- 18) Distance between centre to centre should be minimum 150mm between each fuse outlet and 125mm between fuse outlet and body of panel to be maintained. Distance between 2 no's MCCB shall be minimum 80 mm, & between MCCB outlet & panel body shall be minimum 125 mm.
- 19) The panel shall be provided with two separate earthing terminals connected to earth bus.
- 20) All instruments shall be connected to the earth terminal using 650V grade PVC insulated 2.5 sq mm stranded tinned copper earthing conductor. All Earthing should be routed properly along with body of panel.
- 21) All hinged doors, Covers, Gland Plates shall be connected to the earth terminal, with the help of braided copper conductors of adequate size. Flat earth bus should be protruded out for connection of external earth.
- 22) Eyebolt of suitable sizes shall be provided for lifting arrangements.
- 23) All wiring shall be carried out with 650V grade PVC insulated stranded copper conductors of adequate sizes to suit the rated circuit current.
- 24) The panel shall be powder coated with light shade grade no 631 of IS 5.
- 25) Required number of foundation bolts shall be supplied with the panel.
- 26) Control fuses with control terminals for external cable connections shall be in the breaker chamber only.
- 27) The control terminals shall be as follows:
Stud type with disconnecting facilities for CT circuits
Stud type for voltage and other circuits.
- 28) Fuse bases shall have adequate contact surface with the bus bars provided to ensure that no local heating takes place.
- 29) Lighting System in Feeder Pillar should be LED based.

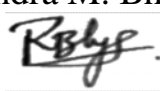
Rev No.	Prepared By & Date	Checked By & Date	Approved for Issue By & Date
R00	Yash M. Mane 	Ajay V. Potdar 	Ravindra M. Bhanage 
	11/01/2024	11/01/2024	11/01/2024

LT Panel: Representative GA drawing & SLD-

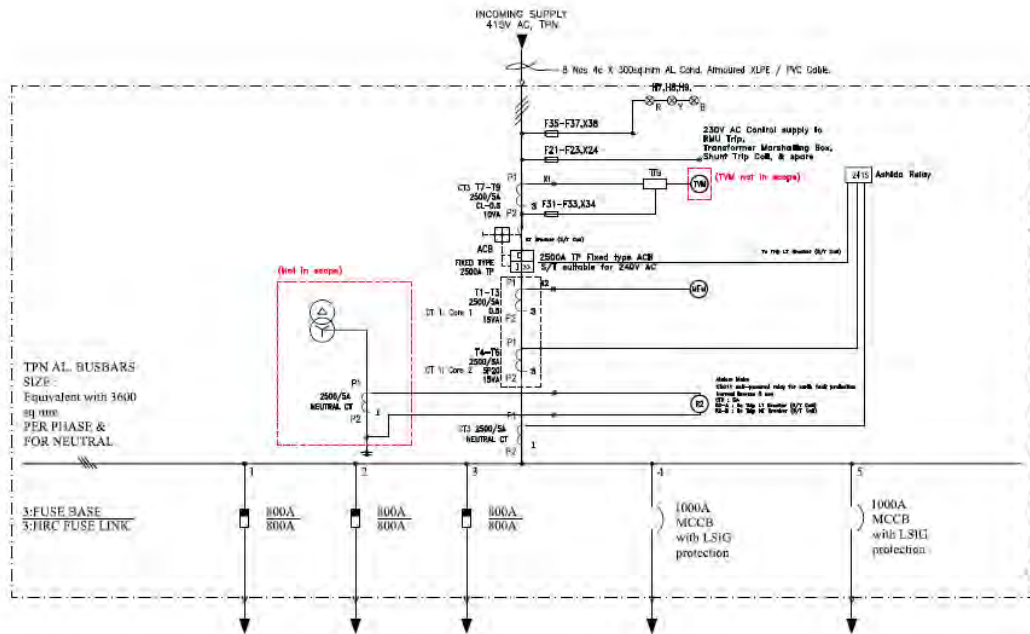
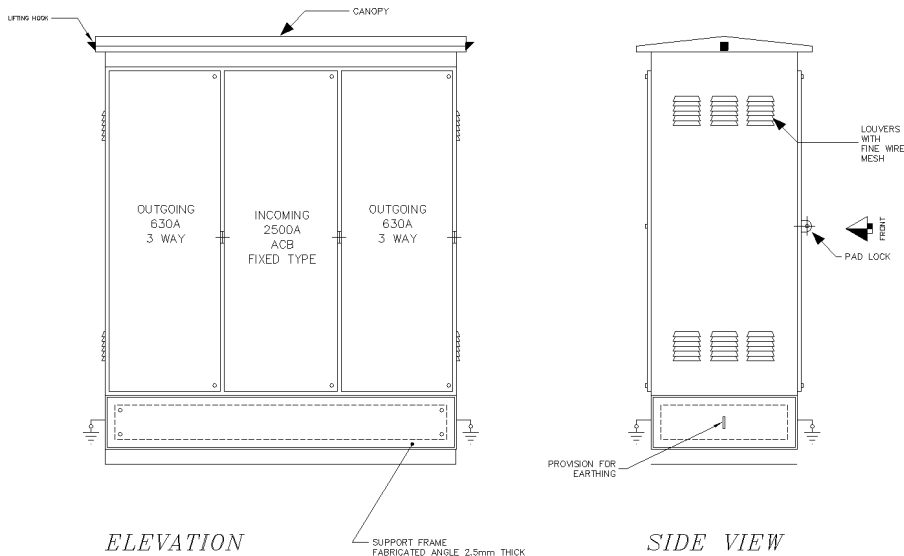

SHEET NO
01 OF 02

Rev No.	Prepared By & Date	Checked By & Date	Approved for Issue By & Date
R00	Yash M. Mane 	Ajay V. Potdar 	Ravindra M. Bhanage
	11/01/2024	11/01/2024	11/01/2024

Control Wiring Diagram:

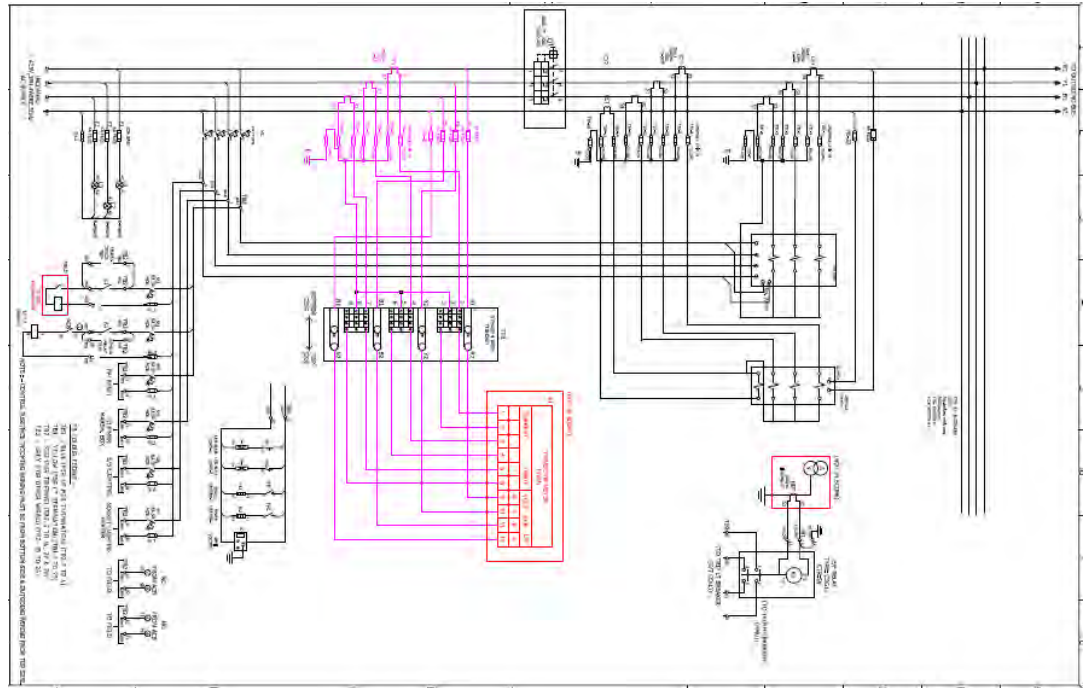



5.1

Specific Requirements

- a) The LT Panel should be 5 Nos. outlets per phase respectively as per tender requirement.
- b) Material Quality Plan, general arrangement drawing and single line diagram of the feeder pillar to be approved before manufacturing.
- c) Adequate cable termination shall be provided as follows

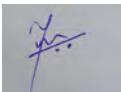

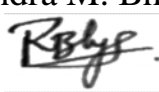
Sr. No.	TYPE	UoM	No. of Cable	Description
1	2500A Incomers	1No.	8	1.1KV, 4C, 300 sqmm AL cond. Armoured XLPE/PVC Cable
2	800 A Fuse Outgoing	3 No. Per outgoing	3	1.1KV, 4C, 300 sqmm AL cond. Armoured XLPE/PVC Cable
3	1000 A MCCB 3P	2 no. Per outgoing	4	1.1KV, 4C, 300 sqmm AL cond. Armoured XLPE/PVC Cable

Rev No.	Prepared By & Date	Checked By & Date	Approved for Issue By & Date
R00	Yash M. Mane 	Ajay V. Potdar 	Ravindra M. Bhanage 
	11/01/2024	11/01/2024	11/01/2024

- d) 2500A Incomer shall be provided with resin cast CTs of ratio 2500/5A for metering & protection.
- 3 no's dual core CT 2500A/5A, Core 1: 0.5 CI, Core 2: 5P20, 15 VA, to be used for MFM.
- 3 no's single core CT 2500A/5A, 0.5, 15 VA, to be used for Energy metering.
- 1 no single core CT 2500A/5A, 5P20, 15 VA, to be used for neutral unbalance protection.
- e) All CT termination should be round plug type. No CT shorting arrangement to be provided. (As per SLD)
- f) Secondary wiring shall be carried out with 1.1KV grade PVC insulated stranded copper conductor of 2.5 Sq. mm for CT circuits and 2.5 Sq. mm for PT and other circuits. All wires will be colour coded.

Sr. No.	Equipment	Colour	Nomenclature of TBs	Types of TBs
1.	TBs of 4 Pole MCB Termination	Blue	TB2	Droppable
2.	TBs for CT Termination	Yellow	TB1	Droppable
3.	TBs for Tripping	Red	TB2	Droppable
4.	All others	Default	TB2	Normal

- g) The feeder pillar panel shall be provided with Alstom Make CDG11 self-powered relay for earth fault protection. The relay type is normal inverse with 3 sec with E/F setting of 0.5 to 2 A.
- h) Test terminal box for Energy Metering should be Front Connection, Screw Type (4SF), 50A to be provided and the convention of the wiring in the TTB should be Incoming from the bottom side and outgoing to Meter from top side. There must not be any partition between Relay & metering box in LV compartment. It should be single door compartment. No lugs shall be provided for wires to meter, TTB, and Fuses (PT secondary). Sealing arrangement to be provided for Energy Meters. Inspection glass (Transparent Toughened Glass) to be provided for viewing of meter.
- i) All Protection/ control wiring must terminate in LV compartment.
- j) Provision to be provided for mounting the energy meter with max dimensions as L x B x D: 360 x 200 x 200 mm (Energy meter will be supplied by TPC). The relay and energy meter shall be installed in the breaker compartment with suitable partitions. The relays shall be supplied by the vendor.
- k) The LT panel shall be equipped with shrouded type anti condensation space heaters with thermostat, internal light with switch & 5A/15A metal clad general-purpose plug socket.

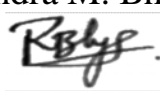
Rev No.	Prepared By & Date	Checked By & Date	Approved for Issue By & Date
R00	Yash M. Mane 	Ajay V. Potdar 	Ravindra M. Bhanage 
	11/01/2024	11/01/2024	11/01/2024

- l) The following separate control circuit 20A, 4 pole MCB duly wired up to terminal block for purchaser's use shall be provided before the circuit breaker in feeder pillars leading to following single pole MCB with neutral links (refer SLD):

Phase and neutral for 230V supply to RMU. (6A)

Phase and neutral for 230V supply to Transformer marshalling box. (6A)

Phase and neutral for external shunt trip coil (6A)

Phase and neutral for FPI reset (6A)

Separate 16A, DP MCB duly wired for Auxiliary supply for LT panel for following purpose,

Phase and neutral for substation lighting (6A)

Phase and neutral for Socket (15A)/ Heater circuit

Phase and neutral for Ashida overcurrent relay (4A)

- m) The following separate control fuses with neutral links duly wired out to a set of stud type link terminals for purchaser's use shall be provided before the circuit breaker in feeder pillars Control fuse Incoming wiring must be from bottom side & Outgoing wiring from top side. (refer SLD):

Three phase and neutral for metering circuit.

Three Phase and neutral for indication lamp

- n) Locking should be of welded type. Earthing jumpers to be provided for all the doors. Louvers with stainless steel wire mesh to be provided on body side and cover plate.

- o) Makes of various bought out items shall be limited to the following:

Sr. No.	Items	Approved Make
1	ACB	L&T/Siemens/Schneider/ABB/Eaton
2.	CT	Reco/Newtek/Pragati/Kappa/ECS/Adcon

- p) Flexible copper braiding should be provided on the doors. Neutral bus shall be connected with earth bus. All control cable should be multi stranded and FRLS. CT ISF should be less than or equal to 5. Close and Open status of the breaker should be available on SCADA through spare auxiliary contact and on LT panel through LED Lamp.



- q) The fuses provide should be of knife type and same should be removable with the help of fuse puller. There shall be no obstruction during removal of outgoing fuses by fuse puller.

- r) The safety locking facility to be provided for putting three nos. of safety locks.

- s) Panel minimum width in mm: 900 mm

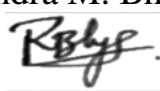

- t) The breaker manufacturer to provide the complete support in terms of training; hand holding to our Testing and O&M staff. The breaker manufacturer to give the support service for next 10 years.

- u) The robust isolating arrangement in the OG fuse compartment to be made.

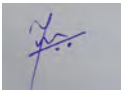

Rev No.	Prepared By & Date	Checked By & Date	Approved for Issue By & Date
R00	Yash M. Mane 	Ajay V. Potdar 	Ravindra M. Bhanage 
	11/01/2024	11/01/2024	11/01/2024

The Tata Power Company Limited		TECHNICAL SPECIFICATION OF 2500 A LT Panel with MCCB & Fuse
ENSE-DS-2028-R00		Date of Issue: 11/01/2024

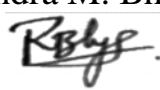
6.0	NAME PLATE AND MARKING	<p>6.1 Name plate- On front door top left side-showing</p> <ol style="list-style-type: none"> 1) Purchaser name & PO number. 2) Manufacturer name 3) Month / year of manufacturing 4) 'Property of Tata Power' <p>6.2 Marking for panel earth stud- Black letter 'E', on riveted Al label</p> <p>6.3 Danger board in English & local language, riveted on doors- White colour background with red lettering on 1.6mm thick Al plate.</p> <p>6.4 SLD shall be engraved & pasted on inside of door.</p> <p>6.5 CT Serial Nos., Ratio & ACB Serial Nos. to be written on doors with marker pen.</p> <p>6.6 Separate metallic name plate with Tata Power Logo of Dimension 12*12 Inches in clear font as shown in Annexure-2.</p>
7.0	TESTS	<p>All routine, acceptance & type tests shall be carried out in accordance with the relevant IS/IEC. Following tests shall be necessarily conducted on the 'Feeder Pillar' in addition to others specified in IS/IEC standards.</p> <p>*In case of any conflict on any technical particular, the stricter requirement mentioned in the relevant standard shall be valid.</p>
7.1	Type test	<p>Type test - Only type tested components – ACBs, Fuses, Insulators & aluminium bus bar shall be accepted. Following type test shall be carried out on the assembly.</p> <ol style="list-style-type: none"> a) Verification of temperature-rise limits – Clause 8.2.1 of IS 8623 b) Verification of dielectric properties – Clause 8.2.2 of IS 8623 c) Verification of short-circuits strength – Clause 8.2.3 of IS 8623 d) Verification of continuity of the protective circuit – Clause 8.2.4 of IS 8623 e) Verification of clearance and creepage distances – Clause 8.2.5 of IS 8623 f) Verification of mechanical operation – Clause 8.2.6 of IS 8623 f) Verification of degree of protection – Clause 8.2.7 of IS 8623
7.2	Routine test	<p>Acceptance & routine test- (Inspection test witness by purchaser as per approved Quality Assurance Plan)</p> <ol style="list-style-type: none"> 1) Visual inspection, dimension checks & paint thickness checks. 2) Bill of material check 3) Insulation resistance test 4) High voltage test 5) Operational check 6) Verification of dielectric properties 7) Tolerances on panel dimensions- Maximum +/- 5mm 8) No negative tolerance on bus bar dimensions & bus bar clearances 9) Stability test shall be conducted on all Panels, to ensure there shall be no tripping in case of unbalance current on earth fault function.

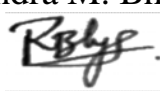

Rev No.	Prepared By & Date	Checked By & Date	Approved for Issue By & Date
R00	Yash M. Mane 	Ajay V. Potdar 	Ravindra M. Bhanage 
	11/01/2024	11/01/2024	11/01/2024

7.3	Acceptance test	<ol style="list-style-type: none"> 1) Visual inspection & dimensional check 2) Verification of clearance and creepage distance 3) Paint thickness check 4) Wiring checks 5) Insulation resistance test 6) HV test 7) Stability test on all Panels, to ensure there shall be no tripping in case of unbalance current on earth fault function. 8) 1 unit from 1st lot shall be tested for Temperature rise test with ACB, MCCB and fuses. (Bidder to arrange for the same, either in factory or in external lab)
8.0	TYPE TEST CERTIFICATE	<p>The Bidder shall furnish the type test certificates for the tests as mentioned above as per the corresponding standards. Type Test to be conducted on similar Design/ rating panel. All the tests shall be conducted at CPRI / ERDA/ NABL as per the relevant standards. Type test should have been conducted in certified Test Laboratories during the period not exceeding 10 years from the date of opening the bid.</p> <p>Type tests shall have been conducted in certified Test laboratories during the period not exceeding 10 years from the date of opening the bid. In case if type test conducted beyond 10 years then bidder to certify on letter head of parent OEM that no design change & no manufacturing plant change occurred from type tested product.</p> <p>In the event of any discrepancy in the test reports, i.e. any test report not acceptable or any/all type tests (including additional type tests, if any) not carried out, same shall be carried out without any cost implication to TATA POWER.</p>
9.0	PRE-DISPATCH INSPECTION	<p>The Material shall be subject to inspection by a duly authorized representative of the TATA POWER COMPANY. Inspection may be made at any stage of manufacture at the discretion of the Purchaser and the equipment, if found unsatisfactory as to workmanship or material, the same is liable to rejection. Bidder shall always grant free access to the places of manufacture to TATA POWER COMPANY `s representatives when the work is in progress. Inspection by the TATA POWER COMPANY or its authorized representatives shall not relieve the Bidder of his obligation of furnishing equipment in accordance with the specifications. TATA POWER COMPANY authorized representatives shall have the right to inspect the design, materials and workmanship and to report thereon, at any stage of manufacture, if found necessary. All facilities shall be extended to our representatives for witnessing the tests. Due notice shall be given to us to enable us to depute our representatives for stage inspection.</p> <p>Material shall be dispatched after specific MDCC (Material Dispatch Clearance Certificate) is issued by TATA POWER COMPANY.</p> <p>Five certified copies of all test certificates including type tests, sample test certificates shall be sent to us for our approval prior to dispatch of materials.</p> <p>Following documents shall be sent along with material</p> <ol style="list-style-type: none"> a) Test reports b) MDCC issued by TATA POWER COMPANY c) Invoice in duplicate d) Packing list e) Drawings & catalogue f) Delivery Challan g) Other Documents (as applicable).

Rev No.	Prepared By & Date	Checked By & Date	Approved for Issue By & Date
R00	Yash M. Mane  11/01/2024	Ajay V. Potdar  11/01/2024	Ravindra M. Bhanage  11/01/2024

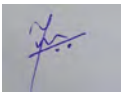

The Tata Power Company Limited		TECHNICAL SPECIFICATION OF 2500 A LT Panel with MCCB & Fuse
ENSE-DS-2028-R00		Date of Issue: 11/01/2024

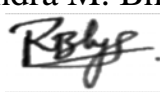
10.0	INSPECTION AFTER RECEIPT AT STORE	<p>The material received at TPC, Mumbai store shall be inspected for acceptance and shall be liable for rejection, if found different from the reports of the pre-dispatch inspection or any other parameters observed after delivery.</p> <p>The material should be delivered at TPC, Mumbai stores within 45 days from the date of manufacturing, same shall be checked during delivery and overdue material shall not be accepted. Bidders to plan the delivery accordingly.</p> <p>Bidders to attend and rectify the same at his own cost. The material shall be accepted in stores only after rectification of any observed flaw. The delay in rectification shall lead to any contractual penalty.</p> <p>Billing shall be processed only after acceptance of the material.</p>
11.0	GUARANTEE	<p>Bidder shall stand guarantee towards design, materials, workmanship & quality of process / manufacturing of items under this contract for due and intended performance of the same, as an integrated product delivered under this contract.</p> <p>In the event any defect is found by the TATA POWER COMPANY up to a period of at least 12 months from the date of commissioning or 24 months from the date of last supplies made under the contract whichever is later, (the time scale of 12/24 months could be enhanced subject to mutual agreements) Bidder shall be liable to undertake to replace/rectify such defects at its own costs, within mutually agreed time frame, and to the entire satisfaction of the Purchaser, failing which the TATA POWER COMPANY will be at liberty to get it replaced/rectified at Bidder's risks and costs and recover all such expenses plus the Purchaser's own charges (@ 20% of expenses incurred), from the Bidder or from the " Security cum Performance Deposit" as the case may be.</p> <p>In case of GP failure, BA shall report at site within 48 hours from intimation and arrange for rectification of fault within a mutually agreed time. In case rectification at site is not possible then alternative arrangement (replacement) to be made by BA within 15 days of intimation of failure.</p> <p>Bidder shall further be responsible for 'free replacement' for another period of THREE years from the end of the guarantee period for any 'Latent Defects' if noticed and reported by the Purchaser.</p>
12.0	PACKING AND TRANSPORT	<p>Bidder shall ensure that the item covered under this specification shall be packaged for rail/road transport in a manner so as to protect the equipment from damage in transit.</p> <ol style="list-style-type: none"> 1) Packing protection- Against shocks, vibration & corrosion, damages during transportation 2) Packing identification labels, to show purchaser name, PO number, quantity of panels, Panel type, Manufacturer serial number 3) Handling instruction- To be marked on packing boxes. 4) Bidders should prefer to use recyclable & environmentally friendly materials for packing. 5) No single use plastic to be used. 6) Packing should be done with environment friendly recyclable materials.
13.0	TENDER SAMPLE	Not Applicable

Rev No.	Prepared By & Date	Checked By & Date	Approved for Issue By & Date
R00	Yash M. Mane 	Ajay V. Potdar 	Ravindra M. Bhanage 
	11/01/2024	11/01/2024	11/01/2024

The Tata Power Company Limited		TECHNICAL SPECIFICATION OF 2500 A LT Panel with MCCB & Fuse
ENSE-DS-2028-R00		Date of Issue: 11/01/2024

14.0	QUALITY CONTROL	<p>The Bidder shall submit with the offer Quality assurance plan indicating the various stages of inspection, the tests and checks which will be carried out on the material of construction, components during manufacture and bought out items and fully assembled component and equipment after finishing. As part of the plan, a schedule for stage and final inspection within the parameters of the delivery schedule shall be furnished.</p> <p>TATA POWER COMPANY shall reserve the sole rights for the type test of a random sample from the lot and in case of any discrepancy or deviation from the Type test certificates submitted along with the Bid; the complete Lot shall be rejected.</p> <p>TATA POWER COMPANY representative or its nominated representative shall have free access to the Bidder's works to carry out inspections.</p> <p>If anything missing in QAP and required as per other clauses of this document, bidder is liable to perform the same without cost implication.</p>
15.0	MINIMUM TESTING FACILITIES	Bidder shall have adequate in-house testing facilities for carrying out all routine tests & acceptance tests as per relevant International / Indian standards and as specified above.
16.0	MANUFACTURING ACTIVITIES	The successful bidder will have to submit first GTP & Drawing with 7 days from placement of outline agreement for approval and complete the approval process within 14 days of outline agreement. The date of Code -2/ Code-1 approval given by TATA Power will be treated as first day for assessment of LD (if applicable).
17.0	SPARES, ACCESSORIES, AND TOOLS	Keys of door
18.0	DRAWING AND DOCUMENTS	<p>Following drawings and documents shall be prepared based on TATA POWER COMPANY specifications and statutory requirements and shall be submitted with the bid. All the documents & drawings shall be in English language</p> <ol style="list-style-type: none"> Completely filled in Technical Particulars General description of the equipment and all components including brochures. General arrangement drawing. Bill of material Experience List Type test certificates Any other technical document, if required
19.0	SCHEDULE "A" GUARANTEED TECHNICAL PARTICULARS	Bidders to comply for all above requirement of specifications clauses & submit signed and stamp copy as technical compliance document.

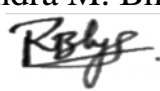
Rev No.	Prepared By & Date	Checked By & Date	Approved for Issue By & Date
R00	Yash M. Mane 	Ajay V. Potdar 	Ravindra M. Bhanage 
	11/01/2024	11/01/2024	11/01/2024

20.0

**SCHEDULE
"B" DEVIATIONS**

The bidders shall set out all deviations from this specification, Clause by Clause in this schedule. Unless specifically mentioned in this schedule, the tender shall be deemed to confirm the purchaser's specifications.

(TO BE ENCLOSED WITH THE BID)

All deviations from this specification shall be set out by the bidders, clause by Clause in this schedule. Unless specifically mentioned in this Schedule, the tender shall be deemed to confirm the purchaser's specifications:



Sr.No.	Clause No.	Details of deviation with justifications

We confirm that there are no deviations apart from those detailed above.

Seal of the Company

Signature :

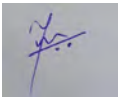
Designation :

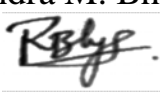
Rev No.	Prepared By & Date	Checked By & Date	Approved for Issue By & Date
R00	Yash M. Mane  11/01/2024	Ajay V. Potdar  11/01/2024	Ravindra M. Bhanage  11/01/2024



The Tata Power Company Limited		TECHNICAL SPECIFICATION OF 2500 A LT Panel with MCCB & Fuse
ENSE-DS-2028-R00		Date of Issue: 11/01/2024

Annexure – 1

Inspection Testing Plan

1. Visual inspection & dimensional check
2. Verification of clearance and creepage distance
3. Paint thickness check
4. Wiring checks
5. Insulation resistance test
6. HV test
7. Stability test on all Panels, to ensure there shall be no tripping in case of unbalance current on earth fault function
8. 1 unit from 1st lot shall be tested for Temperature rise test with ACB, MCCB and fuses. (Bidder to arrange for the same, either in factory or in external lab)

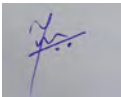
TATA POWER

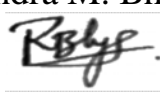
Rev No.	Prepared By & Date	Checked By & Date	Approved for Issue By & Date
R00	Yash M. Mane 	Ajay V. Potdar 	Ravindra M. Bhanage 
	11/01/2024	11/01/2024	11/01/2024

Annexure – 2

Tata power Branding Name plate -

Separate metallic name plate with Tata Power Logo of Dimension 12*12 Inches in clear font as shown below.

Relationship between the two marks- size

The Tata and Tata Power Marks are always used in conjunction with each other, never appearing in isolation on Tata Power communication.

The height of the letter T of Tata (T-height) is the basic measure for all sizes and proportions.

The rounded measure 2T in height, is separated from the Tata lettering by a distance of 1/2T.

The T height of both, the Tata and the Tata Power Marks is to be the same, except in exceptional cases on approval from the Corporate Communications team.





Relationship between the two marks- positioning

The two marks can appear stacked, which is the preferred placement, or linear, by the side of one another.

Centre aligned - Stacked (Preferred)

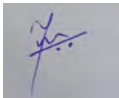

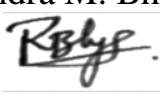

Rev No.	Prepared By & Date	Checked By & Date	Approved for Issue By & Date
R00	Yash M. Mane 	Ajay V. Potdar 	Ravindra M. Bhanage 
	11/01/2024	11/01/2024	11/01/2024

The Tata Power Company Limited		TECHNICAL SPECIFICATION OF 2500 A LT Panel with MCCB & Fuse
ENSE-DS-2028-R00		Date of Issue: 11/01/2024

Annexure – 3

Reference drawings

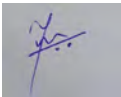
TATA POWER

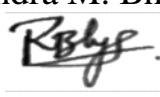
Rev No.	Prepared By & Date	Checked By & Date	Approved for Issue By & Date
R00	Yash M. Mane 	Ajay V. Potdar 	Ravindra M. Bhanage 
	11/01/2024	11/01/2024	11/01/2024

TO OUTGOING BUS
R1 Y1 B1 N1

TPN AL BUSBARS
SIZE:
Equivalent with area
3600 sq.mm
PER PHASE &
FOR NEUTRAL

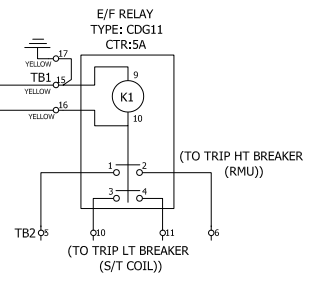
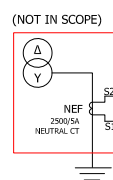

(NOT IN SCOPE)

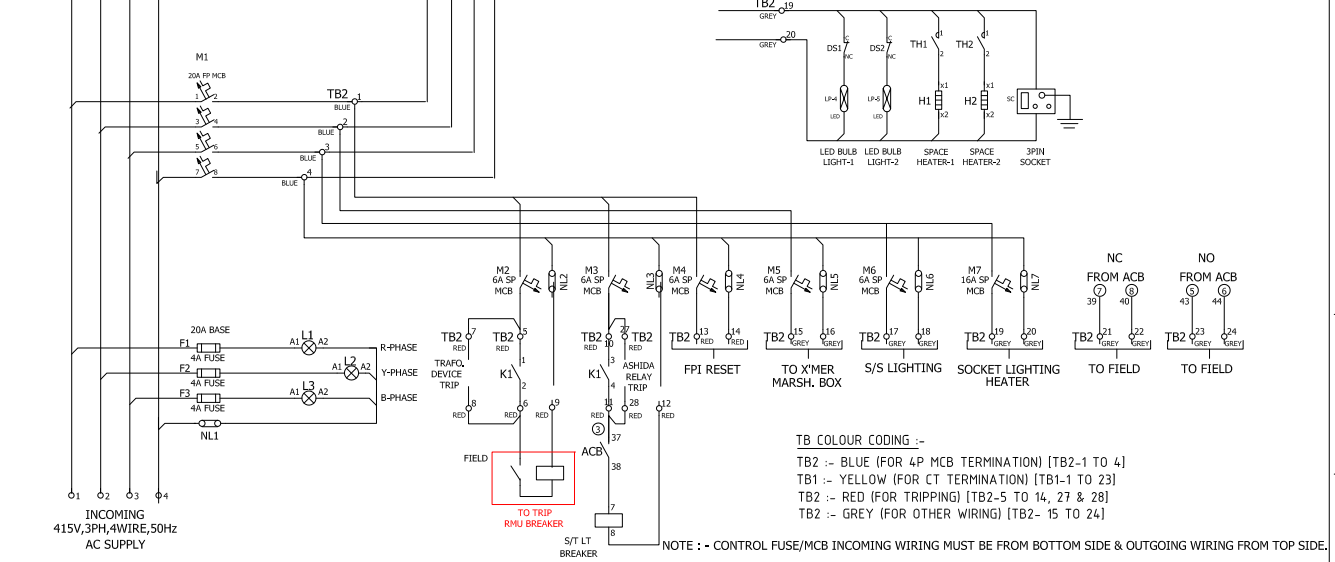
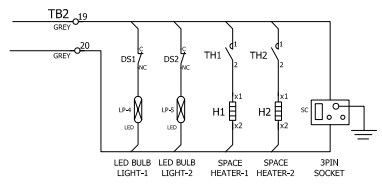
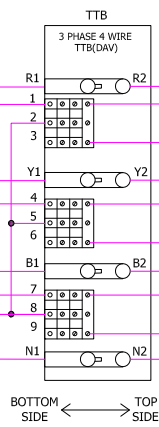
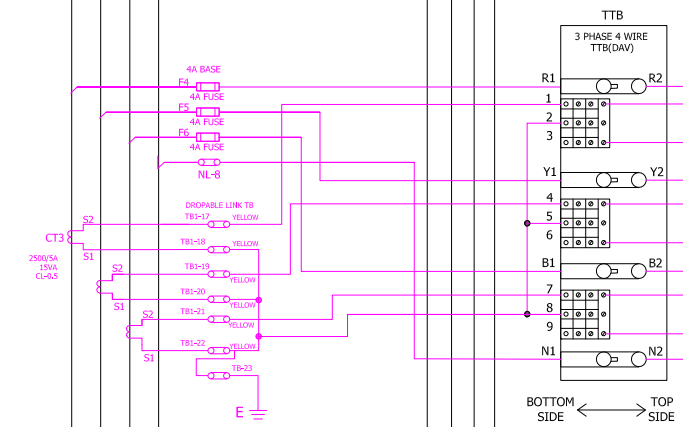
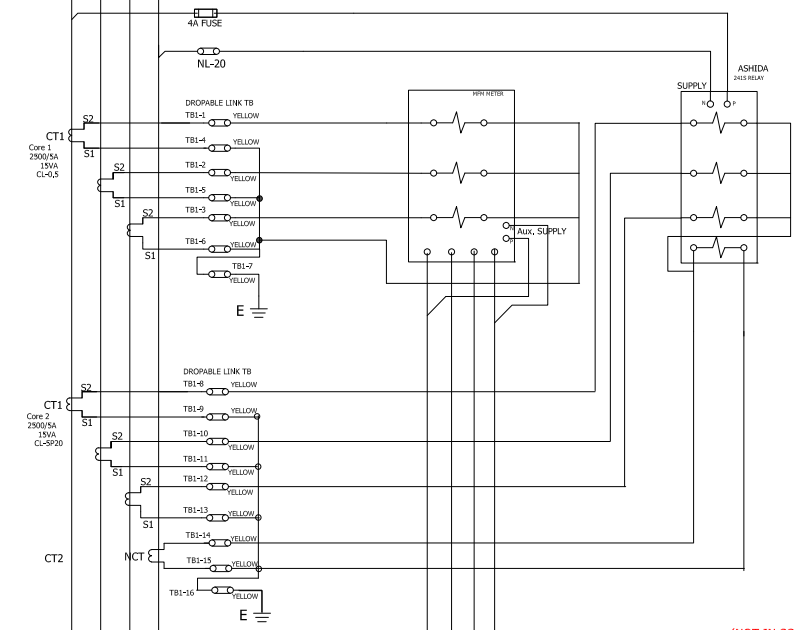
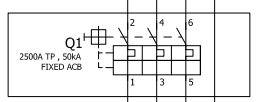
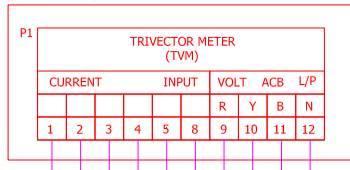

TB COLOUR CODING :-
TB2 :- BLUE (FOR 4P MCB TERMINATION) [TB2-1 TO 4]
TB1 :- YELLOW (FOR CT TERMINATION) [TB1-1 TO 23]
TB2 :- RED (FOR TRIPPING) [TB2-5 TO 14, 27 & 28]
TB2 :- GREY (FOR OTHER WIRING) [TB2- 15 TO 24]

NOTE :- CONTROL FUSE/MCB INCOMING WIRING MUST BE FROM BOTTOM SIDE & OUTGOING WIRING FROM TOP SIDE.

INCOMING SUPPLY
415V AC, TPN

8 Nos 4c X 300sq.mm AL Cond. Armoured XLPE / PVC Cable.

H7,H8,H9.

F35-F37,X38

F21-F23,X24

230V AC Control supply to
RMU Trip,
Transformer Marshalling Box,
Shunt Trip Coil, & spare

TTB

(TVM not in scope)

241S Ashida Relay

CT3 T7-T9
2500/5A
CL-0.5
10VA

P1

X1

3

P2

F31-F33,X34

LT Breaker (S/T Coil)
ACB
FIXED TYPE
2500A TP

2500A TP Fixed type ACB
S/T suitable for 240V AC

To Trip LT Breaker (S/T Coil)

(Not in scope)

T1-T3
2500/5A
0.5
15VA

P1

X2

3

P2

T4-T6
2500/5A
5P20
15VA

P1

X2

3

P2

2500/5A
NEUTRAL CT

P1

1

P2

CT3 2500/5A
NEUTRAL CT

P1

1

P2

Alstom Make
CDG11 self-powered relay for earth fault protection
Normal inverse 3 sec
CTR : 5A
R2-A : To Trip LT Breaker (S/T Coil)
R2-B : To Trip HT Breaker (S/T Coil)

(R2)

TPN AL. BUSBARS
SIZE :
Equivalent with 3600
sq.mm
PER PHASE &
FOR NEUTRAL

3:FUSE BASE
3:HRC FUSE LINK

1

2

3

4

5

800A
800A

800A
800A

800A
800A

1000A
MCCB
with LSIG
protection

1000A
MCCB
with LSIG
protection

TECHNICAL SPECIFICATION

3200 A LT Panel with MCCB & Fuse



The Tata Power Company Ltd.
Engineering Services (ENSE),
Distribution Division,
Senapati Bapat Marg,
Lower Parel,
Mumbai – 400013
Maharashtra

The Tata Power Company Limited		TECHNICAL SPECIFICATION OF 3200 A LT Panel with MCCB & Fuse
ENSE-DS-2029-R00		Date of Issue: 11/01/2024

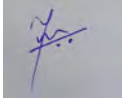

TECHNICAL SPECIFICATION COVER SHEET

Document No: ENSE-DS-2029-R00

Document Title: Technical SPECIFICATION OF 3200 A LT Panels with MCCB & Fuse

R00	ENSE-DS-2029-R00 (for Tendering Purpose)	11/01/2024	YMM		AVP		RMB	
Rev No.	Remarks	Date	Initials	Sign	Initials	Sign	Initials	Sign
			Prepared By		Reviewed By		Approved & Issued By	

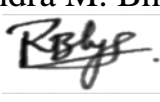

TATA POWER

Rev No.	Prepared By & Date	Checked By & Date	Approved for Issue By & Date
R00	Yash M. Mane 	Ajay V. Potdar 	Ravindra M. Bhanage 
	11/01/2024	11/01/2024	11/01/2024

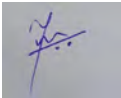

The Tata Power Company Limited		TECHNICAL SPECIFICATION OF 3200 A LT Panel with MCCB & Fuse
ENSE-DS-2029-R00		Date of Issue: 11/01/2024

CONTENTS

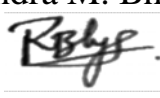
	<u>PAGE NO</u>
1.0 SCOPE	4
2.0 APPLICABLE STANDARDS	4
3.0 CLIMATIC CONDITIONS OF THE INSTALLATION	5
4.0 GENERAL TECHNICAL REQUIREMENTS	5
5.0 GENERAL CONSTRUCTIONS	9
6.0 NAME PLATE & MARKINGS	15
7.0 TESTS, ROUTINE & ACCEPTANCE TESTS	15
8.0 TYPE TEST CERIFICATES	16
9.0 PRE-DISPATCH INSPECTION	16
10.0 INSPECTION AFTER RECEIPT AT STORE	17
11.0 GUARANTEE	17
12.0 PACKING AND TRANSPORT	17
13.0 TENDER SAMPLE	17
14.0 QUALITY CONTROL	18
15.0 MINIMUM TESTING FACILITIES	18
16.0 MANUFACTURING ACTIVITIES	18
17.0 SPARES, ACCESSORIES AND TOOLS	18
18.0 DRAWING AND DOCUMENTS	18
19.0 SCHEDULE "A" GUARANTEED TECHNICAL PARTICULARS	18
20.0 SCHEDULE "B" DEVIATIONS	19
+ ANNEXURE 1, 2 & 3	

Rev No.	Prepared By & Date	Checked By & Date	Approved for Issue By & Date
R00	Yash M. Mane 	Ajay V. Potdar 	Ravindra M. Bhanage 
	11/01/2024	11/01/2024	11/01/2024

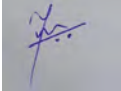
1.0	SCOPE	<p>This specification covers design, engineering, manufacture; shop testing, inspection, painting, packing, and supply of 415V, 3200 A LT Panel with 2 no's 3P 1200 A MCCB, 2 no's 630 A HRC Fuse & 2 no's 800 A HRC Fuse Outgoing Feeders complete with all accessories for efficient and trouble-free operation of the distribution network for Tata Power Company Limited at Mumbai.</p> <p>It is not our intent to specify completely herein all details of design and construction of the equipment. However, the equipment shall conform in all respects to high standards of Engineering design and workmanship and shall be capable of performing in a manner acceptable to the purchaser (TPC) who will interpret the meaning of drawings and specification and shall be entitled to reject any work or material which in his judgement is not in full accordance therewith.</p> <p>All the bought-out items shall be of reputed make and shall be subject to approval by the PURCHASER (TPC) after award of contract.</p>																																				
2.0	APPLICABLE STANDARDS	<p>The equipment shall conform to this specification and latest revision of following codes with all amendments.</p> <table border="1"> <thead> <tr> <th></th> <th>Title</th> <th>Indian standard</th> </tr> </thead> <tbody> <tr> <td>1</td> <td>IS 8623</td> <td>Specification for low voltage switchgear</td> </tr> <tr> <td>2</td> <td>IS 12063/ IEC 60529</td> <td>Classification of degrees of protection provided by Enclosures of Electrical equipment</td> </tr> <tr> <td>3</td> <td>IS 5</td> <td>Color of ready mixed paints</td> </tr> <tr> <td>4</td> <td>IS 5082</td> <td>Wrought Aluminium & Al alloy plates & sheets for electrical application</td> </tr> <tr> <td>5</td> <td>IS 2705</td> <td>Current Transformers</td> </tr> <tr> <td>6</td> <td>IS 2551</td> <td>Danger Notice plates</td> </tr> <tr> <td>7</td> <td>IS 13703-2</td> <td>Low voltage fuses for voltage not exceeding 1000 V AC or 1500 V DC. Part 2 Fuses for use by authorized persons</td> </tr> <tr> <td>8</td> <td>IEC 255</td> <td>Protection Relays</td> </tr> <tr> <td>9</td> <td>IEC 801</td> <td>Control and monitoring</td> </tr> <tr> <td>10</td> <td>IEC 60947-2 /IS 13947-2</td> <td>Low Voltage Switchgear & control gear</td> </tr> <tr> <td>11</td> <td>IEC 60269</td> <td>Low Voltage Fuses</td> </tr> </tbody> </table> <p>In case of any conflict on any technical particular in the specification, the stricter requirement mentioned in the relevant standard shall be valid.</p>		Title	Indian standard	1	IS 8623	Specification for low voltage switchgear	2	IS 12063/ IEC 60529	Classification of degrees of protection provided by Enclosures of Electrical equipment	3	IS 5	Color of ready mixed paints	4	IS 5082	Wrought Aluminium & Al alloy plates & sheets for electrical application	5	IS 2705	Current Transformers	6	IS 2551	Danger Notice plates	7	IS 13703-2	Low voltage fuses for voltage not exceeding 1000 V AC or 1500 V DC. Part 2 Fuses for use by authorized persons	8	IEC 255	Protection Relays	9	IEC 801	Control and monitoring	10	IEC 60947-2 /IS 13947-2	Low Voltage Switchgear & control gear	11	IEC 60269	Low Voltage Fuses
	Title	Indian standard																																				
1	IS 8623	Specification for low voltage switchgear																																				
2	IS 12063/ IEC 60529	Classification of degrees of protection provided by Enclosures of Electrical equipment																																				
3	IS 5	Color of ready mixed paints																																				
4	IS 5082	Wrought Aluminium & Al alloy plates & sheets for electrical application																																				
5	IS 2705	Current Transformers																																				
6	IS 2551	Danger Notice plates																																				
7	IS 13703-2	Low voltage fuses for voltage not exceeding 1000 V AC or 1500 V DC. Part 2 Fuses for use by authorized persons																																				
8	IEC 255	Protection Relays																																				
9	IEC 801	Control and monitoring																																				
10	IEC 60947-2 /IS 13947-2	Low Voltage Switchgear & control gear																																				
11	IEC 60269	Low Voltage Fuses																																				

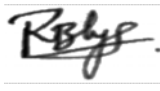
Rev No.	Prepared By & Date	Checked By & Date	Approved for Issue By & Date
R00	Yash M. Mane 	Ajay V. Potdar 	Ravindra M. Bhanage 
	11/01/2024	11/01/2024	11/01/2024

3.0

**CLIMATIC
CONDITIONS OF
THE
INSTALLATION**

1	Maximum ambient temperature	43 deg.C
2	Max. Daily average ambient temp	35 deg.C
3	Min Ambient Temperature	07 deg.C
4	Maximum Relative Humidity	100%
5	Minimum Relative Humidity	40%
6	Average No. of thunderstorm per annum	50
7	Average Annual Rainfall	2380mm
8	Average No. of rainy days per annum	115
9	Rainy months	June to Oct.
10	Altitude above MSL not exceeding	300 meters
11	Average Air Pressure	29.6-inch Hg

Atmosphere is generally laden with mild acid and dust suspended during dry months and subjected to fog in cold months. The design of the equipment and accessories shall be suitable to withstand seismic forces corresponding to an acceleration of 0.1g.

4.0

**GENERAL
TECHNICAL
REQUIREMENTS**

Sr. No	Item Description	Tata Power Requirement
1	Manufacturer	Name
		Manufacturer Address
		Contact telephone no
2	Breaker Rating (ACB)	3200A Manual Fixed Type without any microprocessor relay. 230V AC Shunt tripping coil to be provided.
	Model of ACB	The Model shall be such that current density in current carrying part shall be less than 3 A/sq.mm. (Bidder to mention the model)
	Approved Make	Schneider/ L&T/ Siemens/ C&S/ ABB/ Eaton
3	Main bus bar rating	3200 A
	Bus bar Size for Phase & Neutral	4000 sq.mm for Phase & Neutral
	Earth Bus	1 x 50 x 10 mm GI
4	Type of Installation	Indoor / Outdoor Type
5	No of Incoming feeders	Qty -1no. of 3200A ACB with 10 Nos of 4CX300 sq.mm AI Ar XLPE cables
6	No of outgoing feeders – 1200 A MCCB	Quantity - 2 Nos of 1200A each with 4 no's of 4CX300 sq.mm AI Ar XLPE cables per O/G
	No of outgoing feeders – HRC Fuse	Quantity – 2 Nos of 800A each With 3 no's of 4CX300 sq.mm AI Ar XLPE cables per O/G 2 Nos of 630A each With 2 no's of 4CX300 sq.mm AI Ar XLPE cables per O/G

Rev No.

Prepared By & Date

Checked By & Date

Approved for Issue By
& Date

R00

Yash M. Mane

Ajay V. Potdar



Ravindra M. Bhanage

11/01/2024

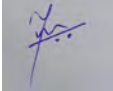

11/01/2024

11/01/2024

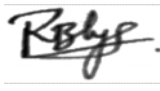

		7	Panel construction	CRCA sheet steel of thickness 3 mm
		8	Panel enclosure class	IP54 - ingress protection
		9	Sheet steel thickness	Doors & Covers - 2.5mm, FRAME - 3mm
		10	Door type for front & rear access	Double door with rear door bolted
		11	Door hinges	Minimum three anti-theft type hinges self-locking type
		12	Padlocking facility	For front door
		13	Master key for all doors	Identical for all panels, 1 no./ panel to be provided
		14	Hardware & Fasteners	All Nuts, Bolts, Washers shall be Hot Dip Galvanized with 80 micron Galvanisation or Alu-Zinc coating. Bolts below 12 mm size shall be SS material.
		14a	Current Carrying part hardware	Each bolt on Bus Bar and Fuse terminal shall be provided with Belleville washer and plain washer. Wherever required bimetallic washers to be provided
		15	Phase & neutral Bus bar	Aluminium grade 19501 (H2) as per IS 5082
			Bus bar size in mm for 3200 A O/G	4000 sq.mm for Phase & Neutral
			3200A ACB Incoming	4000 sq.mm for Phase & Neutral
			ACB O/G LINKS	4000 sq.mm for Phase & Neutral (Dimensions as per feasibility with Breaker palm connection)
		16	Bus bar colour coding for R, Y, B & neutral	Heat shrinkable sleeves with colour Red, Yellow, Blue & Black respectively
		16 a	Bus Bar Heat shrinkable sleeves	Cross-linked Polyolefin (Bidder to specify thickness)
		17	Main bus bar short circuit withstand capacity	Above 50kA for 1 sec
		18	Permissible maximum temperature rise above ambient of 50°C	Busbar: 45 deg C
			Permissible maximum temperature rise above ambient of 50°C	Terminals: 65 deg C
		19	Bus bar support insulators	As per IS13410 SMC / DMC, 1100V grade

Rev No.	Prepared By & Date	Checked By & Date	Approved for Issue By & Date
R00	Yash M. Mane 	Ajay V. Potdar 	Ravindra M. Bhanage 
	11/01/2024	11/01/2024	11/01/2024

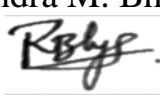
	20	Incoming Cable Size	4C 300 Sq.mm Al Ar XLPE
	21	Outgoing Cable Size	4C 300 Sq.mm Al Ar XLPE
	22	Gland plate at panel bottom	HRCA MS 3mm thickness
	23	Cable termination clearance	600 mm minimum from gland plate & ACB
	24	Fuse Base	800 A
		Approved Make	L&T / Siemens / Schneider / GE Power Control / Jean Muller /Bussmann / ABB
	25	Fuses (800 A & 630 A)	HRC plug-in type gG (General Purpose, Fast acting fuse)
		Approved Make	L&T / Siemens / Schneider / GE Power Control / Jean Muller /Bussmann / ABB
	26	1200 A MCCB 3P	MCCB shall be with Micro Processor Based Release having LSIG Protections. The MCCB shall have Spreader Links & Phase Barriers.
			Approved Make - Schneider/L&T/ABB/Siemens/Eaton
	27	CT's for 3200A Incoming Feeder	7 Nos. Single resin cast. a) 3 no's dual core CT's of ratio 3200/5A • Core 1: Class 0.5 & 15VA burden – For MFM • Core 2: 5P20 & 15VA – For Ashida make O/C+E/F relay b) 3 no's single core CTs of ratio 3200/5 A, Class 0.5 & 15 VA for Energy meter (Energy meter is not in bidder scope) c) 1 no single core CT of ratio 3200/5A, 5P20 & 15 VA for Neutral unbalance protection Approved Make of CTs: Reco/Newtek/Pragati/Kappa/ECS/Adcon
	28	TTB for Metering	Front connection, Screw Type 3 Phase 4 Wire, 4SF, 50 A, DAV/IMP Make
	29	Wiring convention for TTB	Incoming from Bottom Side & Outgoing to Meter from Top side
30	Multifunction Digital meter	Should be communicable on Modbus RS 485	
31	Earth Fault protection relay (NEF)	Alstom make CDG11 self-powered. Relay type is normal inverse with 3 Sec with E/F setting of 0.5 to 2 A	
32	Earthing Hardware	a) Earthing Nut and Bolt shall be M12 SS b) Washers shall be with Hot Dip Galvanized with 80 micron Galvanisation or Alu-Zinc coating.	
32a	Panel Earthing	Earthing provision to be provided on both sides with 50 mm extension of main Earth Bus Bar.	

Rev No.	Prepared By & Date	Checked By & Date	Approved for Issue By & Date
R00	Yash M. Mane 	Ajay V. Potdar 	Ravindra M. Bhanage 
	11/01/2024	11/01/2024	11/01/2024

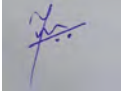

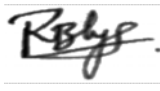
	33	Clearance between live parts	Phase - phase - Minimum 25 mm & Phase - earth - Minimum 20 mm
	34	Distance between each fuse outlet	Centre to Centre - 150mm (Minimum)
	35	Distance between fuse outlet & panel surface	125 mm (Minimum)
	36	Distance between 2 MCCBs	80 mm (Minimum)
	37	Distance between MCCB outlet & panel surface	125 mm (Minimum)
	38	Control terminals for CTs	Stud type with disconnecting facilities
	39	Control terminals for Voltage & other circuits	Stud type
	40	Illumination and Indicating Bulb	LED
	41	Continuous rated operating voltage	440 volt +/- 10%
	42	High voltage withstand capacity	2000 volt at 50 Hz for 1minute
	43	Insulation resistance ph-ph & ph-earth	Minimum 10MOhm with 500V Megger
	44	Labels & name plates	As per Specifications
	45	Surface preparation for painting	Sand blasting or 7 tank process
	46	Painting	Sand blasting or 7 tank process. Light grey shade No 631 of IS-5 Powder coated epoxy paint min thickness 120 micron
	47	Power Supply Socket	5A/15A Plug point socket to be provided
	48	Breaker Barrier	Breaker must have a metallic removable sheet from the front side which will act as a barrier between operator and the breaker. Provision must be given for breaker operation to be done through this barrier.
	49	Branding Plate	All supplied Units shall be fitted with engraved metallic logo of Tata Power on the front side. The Tata Power Co Ltd to be mentioned below the logo with clear font and Dimension 12*12 Inches. * Refer Annexure 2
	50	Panel Dimensions (Min depth of 900 mm)	L X D X H
	51	Numerical Relay	Ashida (ADR 241S) with 4 Element
	52	Bus-bar phase barriers/ Phase separators (R-Y & Y-B)	FRP insulating sheet - (to be placed near to the phase bus-bar) (min 3 mm thickness) shall be provided between bus-bars, so as to ensure that there is no accidental contact with any live parts. (65 mm width)

Rev No.	Prepared By & Date	Checked By & Date	Approved for Issue By & Date
R00	Yash M. Mane 	Ajay V. Potdar 	Ravindra M. Bhanage 
	11/01/2024	11/01/2024	11/01/2024

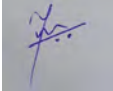

5.0

**GENERAL
CONSTRUCTION**

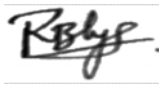
- 1) The feeder pillar frame shall be fabricated using suitable mild steel structural section or pressed and shaped Cold Rolled Closed Annealed (CRCA) sheet of thickness 3 mm.
- 2) Frames shall be enclosed by CRCA sheet of thickness 3mm, smoothly finished, levelled and free from flaws. Doors and cover shall be made of CRCA sheet of thickness not less than 2.5mm. Stiffeners shall be provided, wherever necessary. Gland plates shall be of Hot Rolled Closed Annealed (HRCA) thickness not less than 3 mm. alternatively gland can also be provided between two angles so that removal of gland is easy. The dimension of base frame should be 75mm X 40mm X 5 mm.
- 3) The panel shall be of metal enclosed and outdoor type, support frame mounted type with canopy of adequate slope to avoid water accumulation. Degree of protection shall be IP 54.
- 4) Breaker compartment and fuse compartment should be separated by metallic sheet; the same should be split suitably in order to avoid local heating due to eddy currents generated by three phase bus bars crossing through the same sheet. The breaker compartment should be in center of panel & Outgoings shall be on both the sides of breaker compartment.
- 5) The panel shall be of dust and vermin proof construction and of self-cooled design with adequate louvers on sides and top portion. The louvers shall have fine wire mesh made of brass. The minimum depth of panel shall be 900 mm.
- 6) Labels on the front and rear indicating the panel designation, phase marking and danger signs shall be provided. Single Line Diagram & feeder details shall be engraved and pasted on inside of panel.
- 7) Danger boards shall be provided in local languages on the Hylam sheet below breaker and on front & rear cover with red background and with white letters.
- 8) Hinged doors of lift off type, with concealed type with brass type hinges and captive screws shall be provided on the front side & Back side. Adequate numbers of door hinges shall be provided and should be durable and easy in operation. All doors shall be provided with padlocking facility. The design of doors should permit interchangeability. The back-side doors shall have nut and bolt arrangement. All Hinged doors shall be connected to the earth terminal with 2.5 Sq.mm braided copper wires.
- 9) Cable entry facilities at bottom of panel and removable gland plates of size suitable to accommodate incoming & outgoing cables of sizes, 4 Core 300 Sq mm 1.1 KV XLPE Cable, shall be provided at required locations.
- 10) Distance between Gland plate and cable termination of Air Circuit Breaker should be minimum 600mm.
- 11) The panel shall be provided with gasket all around the perimeter of covers, gland plates, removable covers and doors.
- 12) ACB termination shall be with tinned copper or tinned aluminium Bus Bar. Wherever required bimetallic washer to be provide, if bare copper terminal is provided.

Rev No.	Prepared By & Date	Checked By & Date	Approved for Issue By & Date
R00	Yash M. Mane 	Ajay V. Potdar 	Ravindra M. Bhanage 
	11/01/2024	11/01/2024	11/01/2024

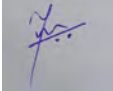
- 13) Busbars shall be of aluminium with Bakelite shrouding, rated for 3200 A, 50 kA for 1 sec and shall have adequate cross section to carry the rated continuous and short time current. Main Bus bar should be continuous/ without any joint. All bus bars, bus taps and joints shall be PVC taped. Neutral bus bar shall be provided on read side & rated for full bus bar rating.
- 14) **The ACBs shall be mechanical operated fixed type 3 Pole with shunt trip coil without any microprocessor protection release. Ashida make (ADR41S) relay to be provided for tripping the breaker with Overcurrent & earth fault protection. Spare ACB contacts for shunt trip should be provided.**
- 15) All fuses shall be of the HRC cartridge type mounted on plug-in type fuse bases having a prospective current of not less than 80 kA.
- 16) MCCB shall be with Micro Processor Based Release having LSIG Protections. The MCCB shall have Spreader Links & Phase Barriers,
- 17) Phase to phase clearance of 25mm and Phase to Neutral / Earth clearance of 20mm shall be provided in the panel.
- 18) Distance between centre to centre should be minimum 150mm between each fuse outlet and 125mm between fuse outlet and body of panel to be maintained. Distance between 2 no's MCCB shall be minimum 80 mm, & between MCCB outlet & panel body shall be minimum 125 mm.
- 19) The panel shall be provided with two separate earthing terminals connected to earth bus.
- 20) All instruments shall be connected to the earth terminal using 650V grade PVC insulated 2.5 sq mm stranded tinned copper earthing conductor. All Earthing should be routed properly along with body of panel.
- 21) All hinged doors, Covers, Gland Plates shall be connected to the earth terminal, with the help of braided copper conductors of adequate size. Flat earth bus should be protruded out for connection of external earth.
- 22) Eyebolt of suitable sizes shall be provided for lifting arrangements.
- 23) All wiring shall be carried out with 650V grade PVC insulated stranded copper conductors of adequate sizes to suit the rated circuit current.
- 24) The panel shall be powder coated with light shade grade no 631 of IS 5.
- 25) Required number of foundation bolts shall be supplied with the panel.
- 26) Control fuses with control terminals for external cable connections shall be in the breaker chamber only.
- 27) The control terminals shall be as follows:
- Stud type with disconnecting facilities for CT circuits
 - Stud type for voltage and other circuits.
- 28) Fuse bases shall have adequate contact surface with the bus bars provided to ensure that no local heating takes place.
- 29) Lighting System in Feeder Pillar should be LED based.

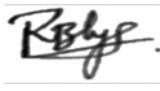
Rev No.	Prepared By & Date	Checked By & Date	Approved for Issue By & Date
R00	Yash M. Mane 	Ajay V. Potdar 	Ravindra M. Bhanage 
	11/01/2024	11/01/2024	11/01/2024

LT Panel: Representative GA drawing & SLD-

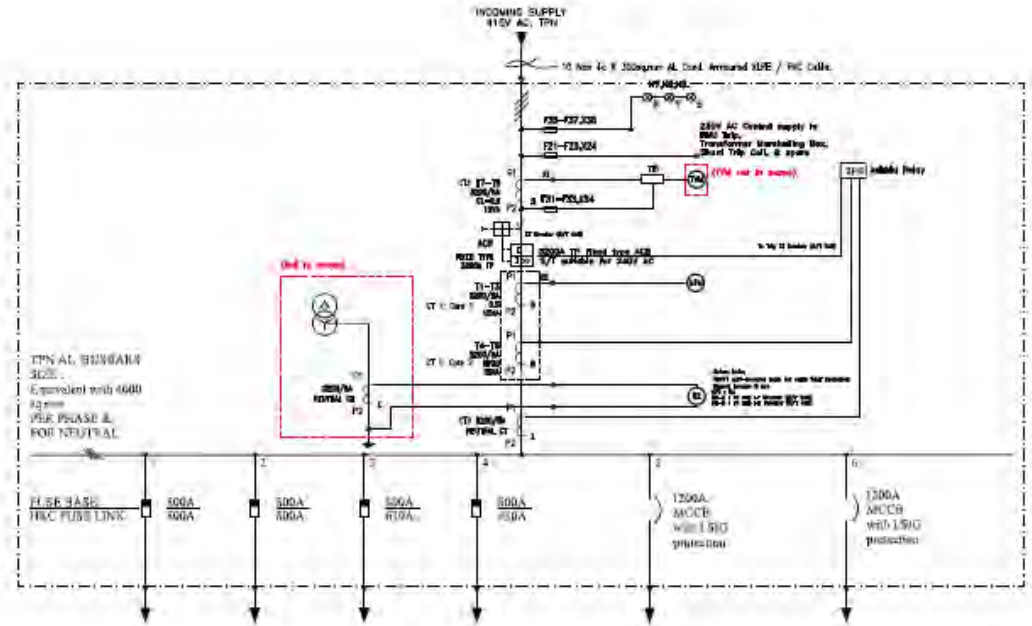
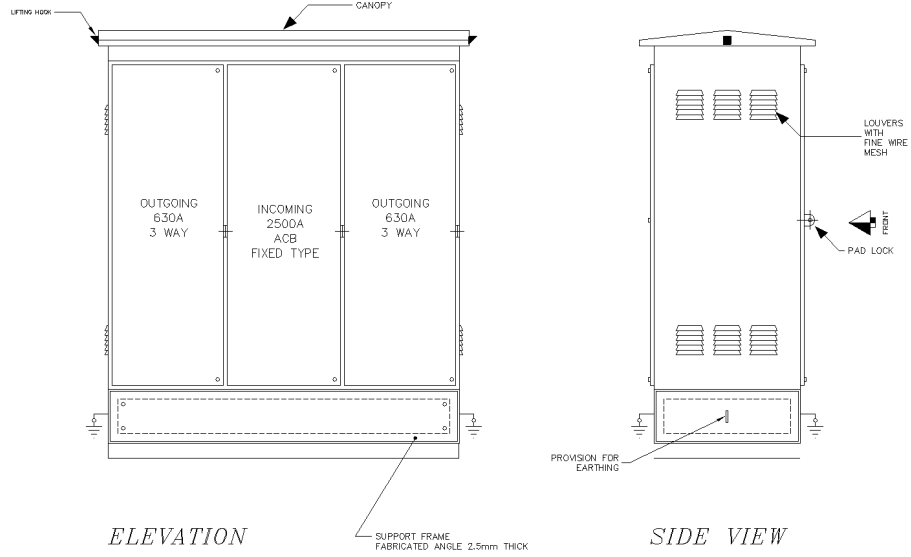

Rev No.	Prepared By & Date	Checked By & Date	Approved for Issue By & Date
R00	Yash M. Mane 	Ajay V. Potdar 	Ravindra M. Bhanage
	11/01/2024	11/01/2024	11/01/2024

Control Wiring Diagram:

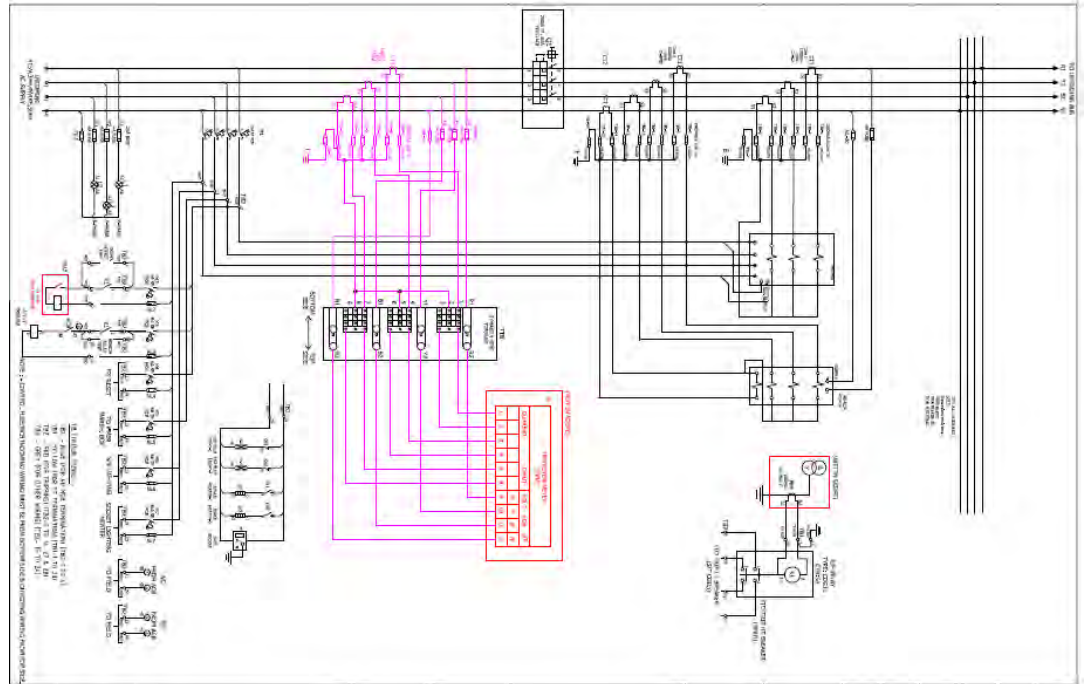

5.1

Specific Requirements

- a) The LT Panel should be 6 Nos. outlets per phase respectively as per tender requirement.
- b) Material Quality Plan, general arrangement drawing and single line diagram of the feeder pillar to be approved before manufacturing.
- c) Adequate cable termination shall be provided as follows



Sr. No.	TYPE	UoM	No. of Cable	Description
1	3200A Incomers	1No.	10	1.1KV, 4C, 300 sqmm AL cond. Armoured XLPE/PVC Cable
2	1000 A MCCB 3P	2 no. Per outgoing	4	1.1KV, 4C, 300 sqmm AL cond. Armoured XLPE/PVC Cable
3	800 A Fuse Outgoing	2 No. Per outgoing	3	1.1KV, 4C, 300 sqmm AL cond. Armoured XLPE/PVC Cable
4	630 A Fuse Outgoing	2 No. Per outgoing	2	1.1KV, 4C, 300 sqmm AL cond. Armoured XLPE/PVC Cable

Rev No.	Prepared By & Date	Checked By & Date	Approved for Issue By & Date
R00	Yash M. Mane 	Ajay V. Potdar 	Ravindra M. Bhanage
	11/01/2024	11/01/2024	11/01/2024

- d) 3200A Incomer shall be provided with resin cast CTs of ratio 3200/5A for metering & protection.
- 3 no's dual core CT 3200A/5A, Core 1: 0.5 CI, Core 2: 5P20, 15 VA, to be used for MFM.
- 3 no's single core CT 3200A/5A, 0.5, 15 VA, to be used for Energy metering.
- 1 no single core CT 3200A/5A, 5P20, 15 VA, to be used for neutral unbalance protection.
- e) All CT termination should be round plug type. No CT shorting arrangement to be provided. (As per SLD)
- f) Secondary wiring shall be carried out with 1.1KV grade PVC insulated stranded copper conductor of 2.5 Sq. mm for CT circuits and 2.5 Sq. mm for PT and other circuits. All wires will be colour coded.

Sr. No.	Equipment	Colour	Nomenclature of TBs	Types of TBs
1.	TBs of 4 Pole MCB Termination	Blue	TB2	Droppable
2.	TBs for CT Termination	Yellow	TB1	Droppable
3.	TBs for Tripping	Red	TB2	Droppable
4.	All others	Default	TB2	Normal

- g) The feeder pillar panel shall be provided with Alstom Make CDG11 self-powered relay for earth fault protection. The relay type is normal inverse with 3 sec with E/F setting of 0.5 to 2 A.
- h) Test terminal box for Energy Metering should be Front Connection, Screw Type (4SF), 50 A to be provided and the convention of the wiring in the TTB should be Incoming from the bottom side and outgoing to Meter from top side. There must not be any partition between Relay & metering box in LV compartment. It should be single door compartment. No lugs shall be provided for wires to meter, TTB, and Fuses (PT secondary). Sealing arrangement to be provided for Energy Meters. Inspection glass (Transparent Toughened Glass) to be provided for viewing of meter.
- i) All Protection/ control wiring must terminate in LV compartment.
- j) Provision to be provided for mounting the energy meter with max dimensions as L x B x D: 360 x 200 x 200 mm (Energy meter will be supplied by TPC). The relay and energy meter shall be installed in the breaker compartment with suitable partitions. The relays shall be supplied by the vendor.
- k) The LT panel shall be equipped with shrouded type anti condensation space heaters with thermostat, internal light with switch & 5A/15A metal clad general-purpose plug socket.

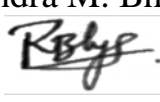
Rev No.	Prepared By & Date	Checked By & Date	Approved for Issue By & Date
R00	Yash M. Mane 	Ajay V. Potdar 	Ravindra M. Bhanage 
	11/01/2024	11/01/2024	11/01/2024

- l) The following separate control circuit 20A, 4 pole MCB duly wired up to terminal block for purchaser's use shall be provided before the circuit breaker in feeder pillars leading to following single pole MCB with neutral links (refer SLD):

Phase and neutral for 230V supply to RMU. (6A)

Phase and neutral for 230V supply to Transformer marshalling box. (6A)

Phase and neutral for external shunt trip coil (6A)

Phase and neutral for FPI reset (6A)

Separate 16A, DP MCB duly wired for Auxiliary supply for LT panel for following purpose,

Phase and neutral for substation lighting (6A)

Phase and neutral for Socket (15A)/ Heater circuit

Phase and neutral for Ashida overcurrent relay (4A)

- m) The following separate control fuses with neutral links duly wired out to a set of stud type link terminals for purchaser's use shall be provided before the circuit breaker in feeder pillars Control fuse Incoming wiring must be from bottom side & Outgoing wiring from top side. (refer SLD):

Three phase and neutral for metering circuit.

Three Phase and neutral for indication lamp

- n) Locking should be of welded type. Earthing jumpers to be provided for all the doors. Louvers with stainless steel wire mesh to be provided on body side and cover plate.

- o) Makes of various bought out items shall be limited to the following:

Sr. No.	Items	Approved Make
1	ACB	Schneider/ L&T/ Siemens/ C&S/ ABB/ Eaton
2.	CT	Reco/Newtek/Pragati/Kappa/ECS/Adcon

- p) Flexible copper braiding should be provided on the doors. Neutral bus shall be connected with earth bus. All control cable should be multi stranded and FRLS. CT ISF should be less than or equal to 5. Close and Open status of the breaker should be available on SCADA through spare auxiliary contact and on LT panel through LED Lamp.



- q) The fuses provide should be of knife type and same should be removable with the help of fuse puller. There shall be no obstruction during removal of outgoing fuses by fuse puller.

- r) The safety locking facility to be provided for putting three nos. of safety locks.

- s) Panel minimum width in mm: 900 mm

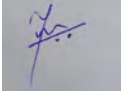

- t) The breaker manufacturer to provide the complete support in terms of training; hand holding to our Testing and O&M staff. The breaker manufacturer to give the support service for next 10 years.

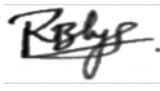
- u) The robust isolating arrangement in the OG fuse compartment to be made.

Rev No.	Prepared By & Date	Checked By & Date	Approved for Issue By & Date
R00	Yash M. Mane 	Ajay V. Potdar 	Ravindra M. Bhanage 
	11/01/2024	11/01/2024	11/01/2024

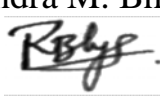

The Tata Power Company Limited		TECHNICAL SPECIFICATION OF 3200 A LT Panel with MCCB & Fuse
ENSE-DS-2029-R00		Date of Issue: 11/01/2024

6.0	NAME PLATE AND MARKING	<p>6.1 Name plate- On front door top left side-showing</p> <ol style="list-style-type: none"> 1) Purchaser name & PO number. 2) Manufacturer name 3) Month / year of manufacturing 4) 'Property of Tata Power' <p>6.2 Marking for panel earth stud- Black letter 'E', on riveted Al label</p> <p>6.3 Danger board in English & local language, riveted on doors- White colour background with red lettering on 1.6mm thick Al plate.</p> <p>6.4 SLD shall be engraved & pasted on inside of door.</p> <p>6.5 CT Serial Nos., Ratio & ACB Serial Nos. to be written on doors with marker pen.</p> <p>6.6 Separate metallic name plate with Tata Power Logo of Dimension 12*12 Inches in clear font as shown in Annexure-2.</p>
7.0	TESTS	<p>All routine, acceptance & type tests shall be carried out in accordance with the relevant IS/IEC. Following tests shall be necessarily conducted on the 'Feeder Pillar' in addition to others specified in IS/IEC standards.</p> <p>*In case of any conflict on any technical particular, the stricter requirement mentioned in the relevant standard shall be valid</p>
7.1	Type test	<p>Type test - Only type tested components – ACBs, Fuses, Insulators & aluminium bus bar shall be accepted. Following type test shall be carried out on the assembly.</p> <ol style="list-style-type: none"> a) Verification of temperature-rise limits – Clause 8.2.1 of IS 8623 b) Verification of dielectric properties – Clause 8.2.2 of IS 8623 c) Verification of short-circuits strength – Clause 8.2.3 of IS 8623 d) Verification of continuity of the protective circuit – Clause 8.2.4 of IS 8623 e) Verification of clearance and creepage distances – Clause 8.2.5 of IS 8623 f) Verification of mechanical operation – Clause 8.2.6 of IS 8623 f) Verification of degree of protection – Clause 8.2.7 of IS 8623
7.2	Routine test	<p>Acceptance & routine test- (Inspection test witness by purchaser as per approved Quality Assurance Plan)</p> <ol style="list-style-type: none"> 1) Visual inspection, dimension checks & paint thickness checks. 2) Bill of material check 3) Insulation resistance test 4) High voltage test 5) Operational check 6) Verification of dielectric properties 7) Tolerances on panel dimensions- Maximum +/- 5mm 8) No negative tolerance on bus bar dimensions & bus bar clearances 9) Stability test shall be conducted on all Panels, to ensure there shall be no tripping in case of unbalance current on earth fault function.

Rev No.	Prepared By & Date	Checked By & Date	Approved for Issue By & Date
R00	Yash M. Mane 	Ajay V. Potdar 	Ravindra M. Bhanage 
	11/01/2024	11/01/2024	11/01/2024

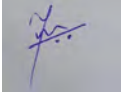

The Tata Power Company Limited		TECHNICAL SPECIFICATION OF 3200 A LT Panel with MCCB & Fuse
ENSE-DS-2029-R00		Date of Issue: 11/01/2024

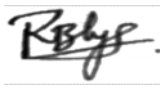
7.3	Acceptance test	<ol style="list-style-type: none"> 1) Visual inspection & dimensional check 2) Verification of clearance and creepage distance 3) Paint thickness check 4) Wiring checks 5) Insulation resistance test 6) HV test 7) Stability test on all Panels, to ensure there shall be no tripping in case of unbalance current on earth fault function. 8) 1 unit from 1st lot shall be tested for Temperature rise test with ACB, MCCB and fuses. (Bidder to arrange for the same, either in factory or in external lab)
8.0	TYPE TEST CERTIFICATE	<p>The Bidder shall furnish the type test certificates for the tests as mentioned above as per the corresponding standards. Type Test to be conducted on similar Design/ rating panel. All the tests shall be conducted at CPR / ERDA/ NABL as per the relevant standards. Type test should have been conducted in certified Test Laboratories during the period not exceeding 10 years from the date of opening the bid.</p> <p>Type tests shall have been conducted in certified Test laboratories during the period not exceeding 10 years from the date of opening the bid. In case if type test conducted beyond 10 years then bidder to certify on letter head of parent OEM that no design change & no manufacturing plant change occurred from type tested product.</p> <p>In the event of any discrepancy in the test reports, i.e. any test report not acceptable or any/all type tests (including additional type tests, if any) not carried out, same shall be carried out without any cost implication to TATA POWER.</p>
9.0	PRE-DISPATCH INSPECTION	<p>The Material shall be subject to inspection by a duly authorized representative of the TATA POWER COMPANY. Inspection may be made at any stage of manufacture at the discretion of the Purchaser and the equipment, if found unsatisfactory as to workmanship or material, the same is liable to rejection. Bidder shall always grant free access to the places of manufacture to TATA POWER COMPANY `s representatives when the work is in progress. Inspection by the TATA POWER COMPANY or its authorized representatives shall not relieve the Bidder of his obligation of furnishing equipment in accordance with the specifications. TATA POWER COMPANY authorized representatives shall have the right to inspect the design, materials and workmanship and to report thereon, at any stage of manufacture, if found necessary. All facilities shall be extended to our representatives for witnessing the tests. Due notice shall be given to us to enable us to depute our representatives for stage inspection.</p> <p>Material shall be dispatched after specific MDCC (Material Dispatch Clearance Certificate) is issued by TATA POWER COMPANY.</p> <p>Five certified copies of all test certificates including type tests, sample test certificates shall be sent to us for our approval prior to dispatch of materials.</p> <p>Following documents shall be sent along with material</p> <ol style="list-style-type: none"> a) Test reports b) MDCC issued by TATA POWER COMPANY c) Invoice in duplicate d) Packing list e) Drawings & catalogue f) Delivery Challan g) Other Documents (as applicable).

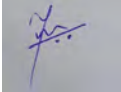

Rev No.	Prepared By & Date	Checked By & Date	Approved for Issue By & Date
R00	Yash M. Mane 	Ajay V. Potdar 	Ravindra M. Bhanage 
	11/01/2024	11/01/2024	11/01/2024

The Tata Power Company Limited		TECHNICAL SPECIFICATION OF 3200 A LT Panel with MCCB & Fuse
ENSE-DS-2029-R00		Date of Issue: 11/01/2024

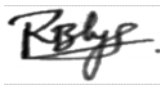
10.0	INSPECTION AFTER RECEIPT AT STORE	<p>The material received at TPC, Mumbai store shall be inspected for acceptance and shall be liable for rejection, if found different from the reports of the pre-dispatch inspection or any other parameters observed after delivery.</p> <p>The material should be delivered at TPC, Mumbai stores within 45 days from the date of manufacturing, same shall be checked during delivery and overdue material shall not be accepted. Bidders to plan the delivery accordingly.</p> <p>Bidders to attend and rectify the same at his own cost. The material shall be accepted in stores only after rectification of any observed flaw. The delay in rectification shall lead to any contractual penalty.</p> <p>Billing shall be processed only after acceptance of the material.</p>
11.0	GUARANTEE	<p>Bidder shall stand guarantee towards design, materials, workmanship & quality of process / manufacturing of items under this contract for due and intended performance of the same, as an integrated product delivered under this contract.</p> <p>In the event any defect is found by the TATA POWER COMPANY up to a period of at least 12 months from the date of commissioning or 24 months from the date of last supplies made under the contract whichever is later, (the time scale of 12/24 months could be enhanced subject to mutual agreements) Bidder shall be liable to undertake to replace/rectify such defects at its own costs, within mutually agreed time frame, and to the entire satisfaction of the Purchaser, failing which the TATA POWER COMPANY will be at liberty to get it replaced/rectified at Bidder's risks and costs and recover all such expenses plus the Purchaser's own charges (@ 20% of expenses incurred), from the Bidder or from the " Security cum Performance Deposit" as the case may be.</p> <p>In case of GP failure, BA shall report at site within 48 hours from intimation and arrange for rectification of fault within a mutually agreed time. In case rectification at site is not possible then alternative arrangement (replacement) to be made by BA within 15 days of intimation of failure.</p> <p>Bidder shall further be responsible for 'free replacement' for another period of THREE years from the end of the guarantee period for any 'Latent Defects' if noticed and reported by the Purchaser.</p>
12.0	PACKING AND TRANSPORT	<p>Bidder shall ensure that the item covered under this specification shall be packaged for rail/road transport in a manner so as to protect the equipment from damage in transit.</p> <ol style="list-style-type: none"> 1) Packing protection- Against shocks, vibration & corrosion, damages during transportation 2) Packing identification labels, to show purchaser name, PO number, quantity of panels, Panel type, Manufacturer serial number 3) Handling instruction- To be marked on packing boxes. 4) Bidders should prefer to use recyclable & environmentally friendly materials for packing. 5) No single use plastic to be used. 6) Packing should be done with environment friendly recyclable materials.
13.0	TENDER SAMPLE	Not Applicable

Rev No.	Prepared By & Date	Checked By & Date	Approved for Issue By & Date
R00	Yash M. Mane 	Ajay V. Potdar 	Ravindra M. Bhanage 
	11/01/2024	11/01/2024	11/01/2024

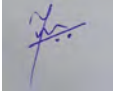
14.0	QUALITY CONTROL	<p>The Bidder shall submit with the offer Quality assurance plan indicating the various stages of inspection, the tests and checks which will be carried out on the material of construction, components during manufacture and bought out items and fully assembled component and equipment after finishing. As part of the plan, a schedule for stage and final inspection within the parameters of the delivery schedule shall be furnished.</p> <p>TATA POWER COMPANY shall reserve the sole rights for the type test of a random sample from the lot and in case of any discrepancy or deviation from the Type test certificates submitted along with the Bid; the complete Lot shall be rejected.</p> <p>TATA POWER COMPANY representative or its nominated representative shall have free access to the Bidder's works to carry out inspections.</p> <p>If anything missing in QAP and required as per other clauses of this document, bidder is liable to perform the same without cost implication.</p>
15.0	MINIMUM TESTING FACILITIES	Bidder shall have adequate in-house testing facilities for carrying out all routine tests & acceptance tests as per relevant International / Indian standards and as specified above.
16.0	MANUFACTURING ACTIVITIES	The successful bidder will have to submit first GTP & Drawing with 7 days from placement of outline agreement for approval and complete the approval process within 14 days of outline agreement. The date of Code -2/ Code-1 approval given by TATA Power will be treated as first day for assessment of LD (if applicable).
17.0	SPARES, ACCESSORIES, AND TOOLS	Keys of door
18.0	DRAWING AND DOCUMENTS	<p>Following drawings and documents shall be prepared based on TATA POWER COMPANY specifications and statutory requirements and shall be submitted with the bid. All the documents & drawings shall be in English language</p> <p>a) Completely filled in Technical Particulars</p> <p>b) General description of the equipment and all components including brochures.</p> <p>c) General arrangement drawing.</p> <p>d) Bill of material</p> <p>e) Experience List</p> <p>f) Type test certificates</p> <p>g) Any other technical document, if required</p>
19.0	SCHEDULE "A" GUARANTEED TECHNICAL PARTICULARS	Bidders to comply for all above requirement of specifications clauses & submit signed and stamp copy as technical compliance document.

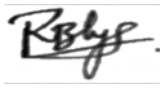
Rev No.	Prepared By & Date	Checked By & Date	Approved for Issue By & Date
R00	Yash M. Mane 	Ajay V. Potdar 	Ravindra M. Bhanage 
	11/01/2024	11/01/2024	11/01/2024

20.0

**SCHEDULE
"B" DEVIATIONS**

The bidders shall set out all deviations from this specification, Clause by Clause in this schedule. Unless specifically mentioned in this schedule, the tender shall be deemed to confirm the purchaser's specifications.

(TO BE ENCLOSED WITH THE BID)

All deviations from this specification shall be set out by the bidders, clause by Clause in this schedule. Unless specifically mentioned in this Schedule, the tender shall be deemed to confirm the purchaser's specifications:



Sr.No.	Clause No.	Details of deviation with justifications

We confirm that there are no deviations apart from those detailed above.

Seal of the Company

Signature :

Designation :

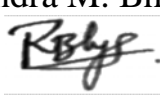
Rev No.	Prepared By & Date	Checked By & Date	Approved for Issue By & Date
R00	Yash M. Mane  11/01/2024	Ajay V. Potdar  11/01/2024	Ravindra M. Bhanage  11/01/2024



The Tata Power Company Limited		TECHNICAL SPECIFICATION OF 3200 A LT Panel with MCCB & Fuse
ENSE-DS-2029-R00		Date of Issue: 11/01/2024

Annexure – 1

Inspection Testing Plan

1. Visual inspection & dimensional check
2. Verification of clearance and creepage distance
3. Paint thickness check
4. Wiring checks
5. Insulation resistance test
6. HV test
7. Stability test on all Panels, to ensure there shall be no tripping in case of unbalance current on earth fault function
8. 1 unit from 1st lot shall be tested for Temperature rise test with ACB, MCCB and fuses. (Bidder to arrange for the same, either in factory or in external lab)

TATA POWER

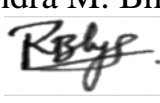
Rev No.	Prepared By & Date	Checked By & Date	Approved for Issue By & Date
R00	Yash M. Mane 	Ajay V. Potdar 	Ravindra M. Bhanage 
	11/01/2024	11/01/2024	11/01/2024

Annexure – 2

Tata power Branding Name plate -

Separate metallic name plate with Tata Power Logo of Dimension 12*12 Inches in clear font as shown below.

Relationship between the two marks- size

The Tata and Tata Power Marks are always used in conjunction with each other, never appearing in isolation on Tata Power communication.

The height of the letter T of Tata (T-height) is the basic measure for all sizes and proportions.

The rounded measure 2T in height, is separated from the Tata lettering by a distance of 1/2T.

The T height of both, the Tata and the Tata Power Marks is to be the same, except in exceptional cases on approval from the Corporate Communications team.





Relationship between the two marks- positioning

The two marks can appear stacked, which is the preferred placement, or linear, by the side of one another.

Centre aligned - Stacked (Preferred)

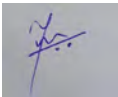

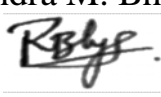

Rev No.	Prepared By & Date	Checked By & Date	Approved for Issue By & Date
R00	Yash M. Mane 	Ajay V. Potdar 	Ravindra M. Bhanage 
	11/01/2024	11/01/2024	11/01/2024

The Tata Power Company Limited		TECHNICAL SPECIFICATION OF 3200 A LT Panel with MCCB & Fuse
ENSE-DS-2029-R00		Date of Issue: 11/01/2024

Annexure – 3

Reference drawings

TATA POWER

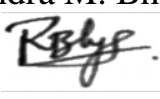
Rev No.	Prepared By & Date	Checked By & Date	Approved for Issue By & Date
R00	Yash M. Mane 	Ajay V. Potdar 	Ravindra M. Bhanage 
	11/01/2024	11/01/2024	11/01/2024

TO OUTGOING BUS
R1 Y1 B1 N1

TPN AL. BUSBARS
SIZE :
Equivalent with area
4000 sq.mm
PER PHASE &
FOR NEUTRAL

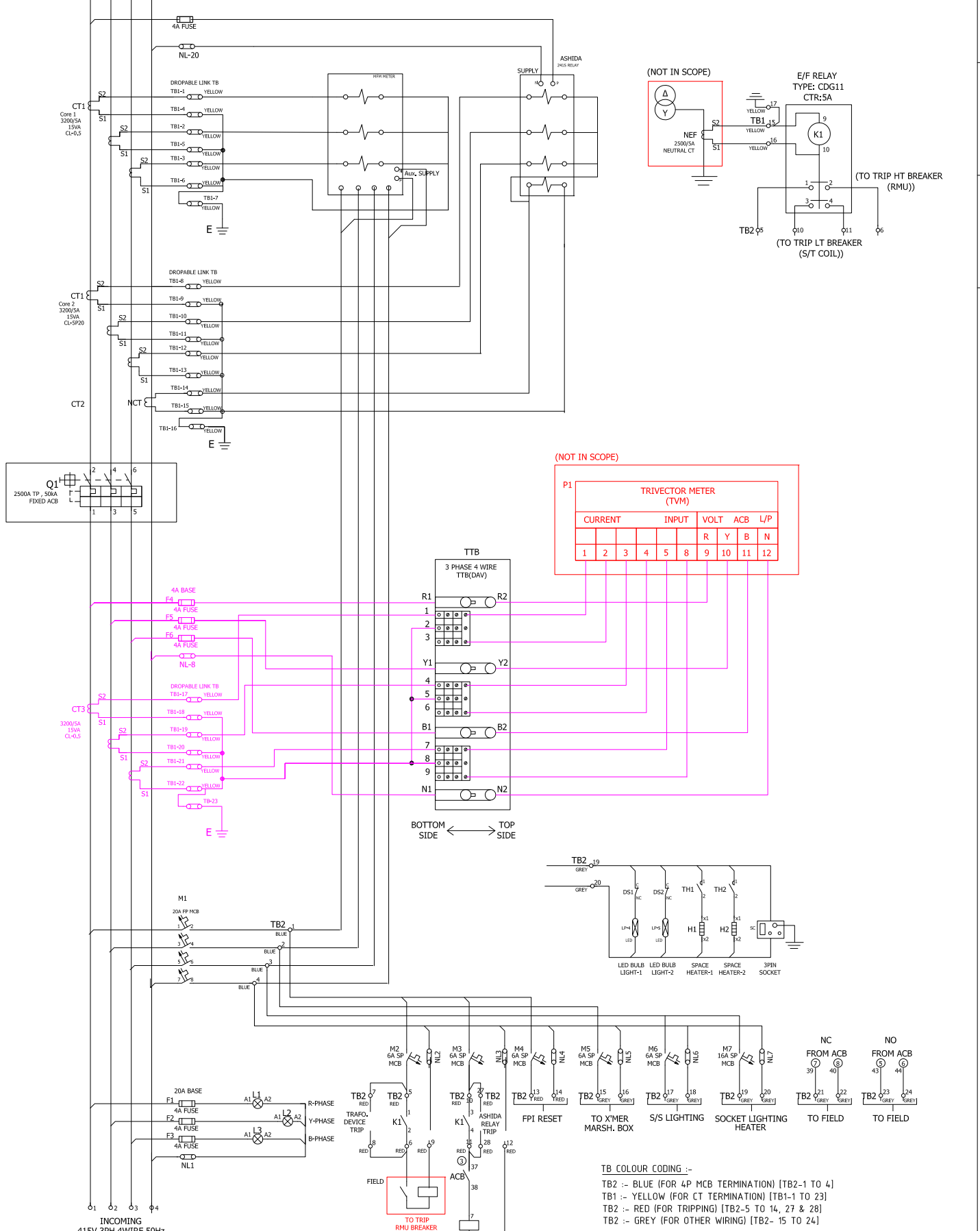

(NOT IN SCOPE)

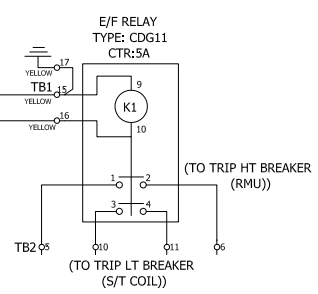
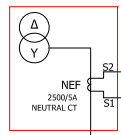

(NOT IN SCOPE)

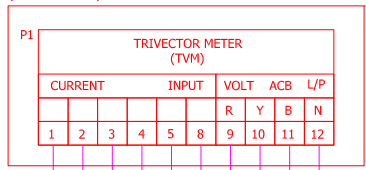

BOTTOM SIDE ← → TOP SIDE

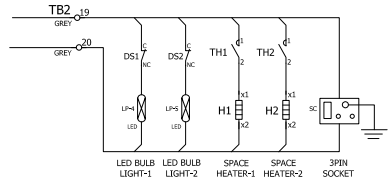

TB COLOUR CODING :-
 TB2 :- BLUE (FOR 4P MCB TERMINATION) [TB2-1 TO 4]
 TB1 :- YELLOW (FOR CT TERMINATION) [TB1-1 TO 23]
 TB2 :- RED (FOR TRIPPING) [TB2-5 TO 14, 27 & 28]
 TB2 :- GREY (FOR OTHER WIRING) [TB2- 15 TO 24]

NOTE :- CONTROL FUSE/MCB INCOMING WIRING MUST BE FROM BOTTOM SIDE & OUTGOING WIRING FROM TOP SIDE.

INCOMING SUPPLY
415V AC, TPN

10 Nos 4c X 300sq.mm AL Cond. Armoured XLPE / PVC Cable.

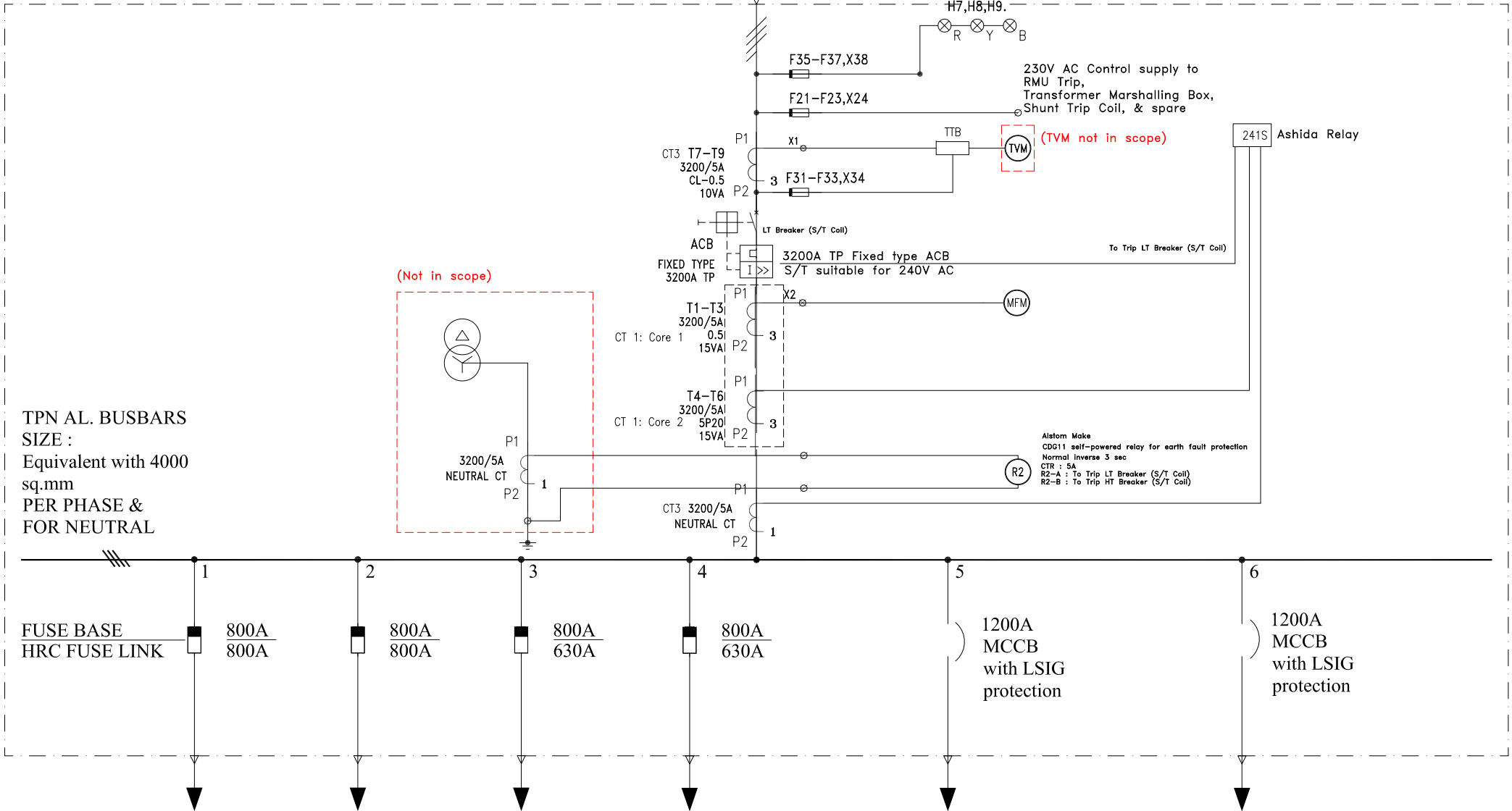

TPN AL. BUSBARS
SIZE :
Equivalent with 4000
sq.mm
PER PHASE &
FOR NEUTRAL

FUSE BASE
HRC FUSE LINK

800A
800A

800A
800A

800A
630A

800A
630A

1200A
MCCB
with LSIG
protection

1200A
MCCB
with LSIG
protection

TECHNICAL SPECIFICATION

6 Way & 8 Way 2500 A LT Panel



The Tata Power Company Ltd.
Engineering Services (ENSE),
Distribution Division,
Senapati Bapat Marg,
Lower Parel,
Mumbai – 400013
Maharashtra

The Tata Power Company Limited		TECHNICAL SPECIFICATION OF 6 Way & 8 Way 2500 A LT Panel
ENSE-DS-2030-R00		Date of Issue: 11/01/2024

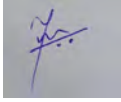

TECHNICAL SPECIFICATION COVER SHEET

Document No: ENSE-DS-2030-R00

Document Title: Technical SPECIFICATION OF 6 Way & 8 Way 2500 A LT Panels

R00	ENSE-DS-2030-R00 (For Tendering Purpose)	11/01/2024	YMM		AVP		RMB	
Rev No.	Remarks	Date	Initials	Sign	Initials	Sign	Initials	Sign
			Prepared By		Reviewed By		Approved & Issued By	

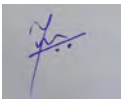

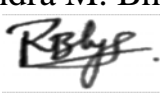
TATA POWER

Rev No.	Prepared By & Date	Checked By & Date	Approved for Issue By & Date
R00	Yash M. Mane 	Ajay V. Potdar 	Ravindra M. Bhanage 
	11/01/2024	11/01/2024	11/01/2024

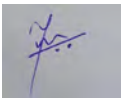

The Tata Power Company Limited		TECHNICAL SPECIFICATION OF 6 Way & 8 Way 2500 A LT Panel
ENSE-DS-2030-R00		Date of Issue: 11/01/2024

CONTENTS

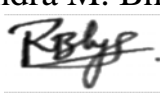
	<u>PAGE NO</u>
1.0 SCOPE	4
2.0 APPLICABLE STANDARDS	4
3.0 CLIMATIC CONDITIONS OF THE INSTALLATION	5
4.0 GENERAL TECHNICAL REQUIREMENTS	5
5.0 GENERAL CONSTRUCTIONS	9
6.0 NAME PLATE & MARKINGS	16
7.0 TESTS, ROUTINE & ACCEPTANCE TESTS	16
8.0 TYPE TEST CERIFICATES	17
9.0 PRE-DISPATCH INSPECTION	17
10.0 INSPECTION AFTER RECEIPT AT STORE	18
11.0 GUARANTEE	18
12.0 PACKING AND TRANSPORT	18
13.0 TENDER SAMPLE	18
14.0 QUALITY CONTROL	19
15.0 MINIMUM TESTING FACILITIES	19
16.0 MANUFACTURING ACTIVITIES	19
17.0 SPARES, ACCESSORIES AND TOOLS	19
18.0 DRAWING AND DOCUMENTS	19
19.0 SCHEDULE "A" GUARANTEED TECHNICAL PARTICULARS	19
20.0 SCHEDULE "B" DEVIATIONS	20
+ ANNEXURE 1, 2 & 3	

Rev No.	Prepared By & Date	Checked By & Date	Approved for Issue By & Date
R00	Yash M. Mane 	Ajay V. Potdar 	Ravindra M. Bhanage 
	11/01/2024	11/01/2024	11/01/2024

1.0	SCOPE	<p>This specification covers design, engineering, manufacture; shop testing, inspection, painting, packing, and supply of 415V, 2500 A LT Panel with 6 or 8 no Outgoing Feeders complete with all accessories for efficient and trouble-free operation of the distribution network for Tata Power Company Limited at Mumbai.</p> <p>It is not our intent to specify completely herein all details of design and construction of the equipment. However, the equipment shall conform in all respects to high standards of Engineering design and workmanship and shall be capable of performing in a manner acceptable to the purchaser (TPC) who will interpret the meaning of drawings and specification and shall be entitled to reject any work or material which in his judgement is not in full accordance therewith.</p> <p>All the bought-out items shall be of reputed make and shall be subject to approval by the PURCHASER (TPC) after award of contract.</p>																																				
2.0	APPLICABLE STANDARDS	<p>The equipment shall conform to this specification and latest revision of following codes with all amendments.</p> <table border="1" style="width: 100%; border-collapse: collapse;"> <thead> <tr> <th style="width: 5%;"></th> <th style="width: 30%;">Title</th> <th style="width: 65%;">Indian standard</th> </tr> </thead> <tbody> <tr> <td style="text-align: center;">1</td> <td>IS 8623</td> <td>Specification for low voltage switchgear</td> </tr> <tr> <td style="text-align: center;">2</td> <td>IS 12063/ IEC 60529</td> <td>Classification of degrees of protection provided by Enclosures of Electrical equipment</td> </tr> <tr> <td style="text-align: center;">3</td> <td>IS 5</td> <td>Color of ready mixed paints</td> </tr> <tr> <td style="text-align: center;">4</td> <td>IS 5082</td> <td>Wrought Aluminium & Al alloy plates & sheets for electrical application</td> </tr> <tr> <td style="text-align: center;">5</td> <td>IS 2705</td> <td>Current Transformers</td> </tr> <tr> <td style="text-align: center;">6</td> <td>IS 2551</td> <td>Danger Notice plates</td> </tr> <tr> <td style="text-align: center;">7</td> <td>IS 13703-2</td> <td>Low voltage fuses for voltage not exceeding 1000 V AC or 1500 V DC. Part 2 Fuses for use by authorized persons</td> </tr> <tr> <td style="text-align: center;">8</td> <td>IEC 255</td> <td>Protection Relays</td> </tr> <tr> <td style="text-align: center;">9</td> <td>IEC 801</td> <td>Control and monitoring</td> </tr> <tr> <td style="text-align: center;">10</td> <td>IEC 60947-2 /IS 13947-2</td> <td>Low Voltage Switchgear & control gear</td> </tr> <tr> <td style="text-align: center;">11</td> <td>IEC 60269</td> <td>Low Voltage Fuses</td> </tr> </tbody> </table> <p>In case of any conflict on any technical particular in the specification, the stricter requirement mentioned in the relevant standard shall be valid.</p>		Title	Indian standard	1	IS 8623	Specification for low voltage switchgear	2	IS 12063/ IEC 60529	Classification of degrees of protection provided by Enclosures of Electrical equipment	3	IS 5	Color of ready mixed paints	4	IS 5082	Wrought Aluminium & Al alloy plates & sheets for electrical application	5	IS 2705	Current Transformers	6	IS 2551	Danger Notice plates	7	IS 13703-2	Low voltage fuses for voltage not exceeding 1000 V AC or 1500 V DC. Part 2 Fuses for use by authorized persons	8	IEC 255	Protection Relays	9	IEC 801	Control and monitoring	10	IEC 60947-2 /IS 13947-2	Low Voltage Switchgear & control gear	11	IEC 60269	Low Voltage Fuses
	Title	Indian standard																																				
1	IS 8623	Specification for low voltage switchgear																																				
2	IS 12063/ IEC 60529	Classification of degrees of protection provided by Enclosures of Electrical equipment																																				
3	IS 5	Color of ready mixed paints																																				
4	IS 5082	Wrought Aluminium & Al alloy plates & sheets for electrical application																																				
5	IS 2705	Current Transformers																																				
6	IS 2551	Danger Notice plates																																				
7	IS 13703-2	Low voltage fuses for voltage not exceeding 1000 V AC or 1500 V DC. Part 2 Fuses for use by authorized persons																																				
8	IEC 255	Protection Relays																																				
9	IEC 801	Control and monitoring																																				
10	IEC 60947-2 /IS 13947-2	Low Voltage Switchgear & control gear																																				
11	IEC 60269	Low Voltage Fuses																																				

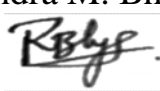
Rev No.	Prepared By & Date	Checked By & Date	Approved for Issue By & Date
R00	Yash M. Mane 	Ajay V. Potdar 	Ravindra M. Bhanage 
	11/01/2024	11/01/2024	11/01/2024



3.0 CLIMATIC CONDITIONS OF THE INSTALLATION

1	Maximum ambient temperature	43 deg.C
2	Max. Daily average ambient temp	35 deg.C
3	Min Ambient Temperature	07 deg.C
4	Maximum Relative Humidity	100%
5	Minimum Relative Humidity	40%
6	Average No. of thunderstorm per annum	50
7	Average Annual Rainfall	2380mm
8	Average No. of rainy days per annum	115
9	Rainy months	June to Oct.
10	Altitude above MSL not exceeding	300 meters
11	Average Air Pressure	29.6-inch Hg



Atmosphere is generally laden with mild acid and dust suspended during dry months and subjected to fog in cold months. The design of the equipment and accessories shall be suitable to withstand seismic forces corresponding to an acceleration of 0.1g.

4.0 GENERAL TECHNICAL REQUIREMENTS

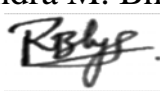

Sr. No	Item Description	Tata Power Requirement
1	Manufacturer	Name
		Manufacturer Address
		Contact telephone no
2	Breaker Rating (ACB)	2500A Manual Fixed Type without any microprocessor relay. 230V AC Shunt tripping coil to be provided.
	Model of ACB	The Model shall be such that current density in current carrying part shall be less than 3 A/sq.mm. (Bidder to mention the model)
	Approved Make	Schneider/ L&T/ Siemens/ C&S/ ABB/ Eaton
3	Main bus bar rating	2500 A
	Bus bar Size for Phase & Neutral	3600 sq.mm (2x150mmx12mm or equivalent) for Phase & Neutral
	Earth Bus	1 x 50 x 10 mm GI
4	Type of Installation	Indoor / Outdoor Type
5	No of Incoming feeders	Qty -1no. of 2500A ACB with 8 Nos of 4CX300 sq.mm Al Ar XLPE cables
6	No of outgoing feeders (8 Way)	Quantity -8 Nos of 630A each with 2 nos of 4CX300 sq.mm Al Ar XLPE cables per O/G
	No of outgoing feeders (6 Way)	Quantity -6 Nos of 630A each with 2 nos of 4CX300 sq.mm Al Ar XLPE cables per O/G

Rev No.	Prepared By & Date	Checked By & Date	Approved for Issue By & Date
R00	Yash M. Mane 	Ajay V. Potdar 	Ravindra M. Bhanage 
	11/01/2024	11/01/2024	11/01/2024

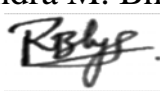

7	Panel construction	CRCA sheet steel of thickness 3 mm
8	Panel enclosure class	IP54 - ingress protection
9	Sheet steel thickness	Doors & Covers - 2.5mm, FRAME - 3mm
10	Door type for front & rear access	Double door with rear door bolted
11	Door hinges	Minimum three anti-theft type hinges self-locking type
12	Padlocking facility	For front door
13	Master key for all doors	Identical for all panels, 1 no./ panel to be provided
14	Hardware & Fasteners	All Nuts, Bolts, Washers shall be Hot Dip Galvanized with 80 micron Galvanisation or Alu-Zinc coating. Bolts below 12 mm size shall be SS material.
14a	Current Carrying part hardware	Each bolt on Bus Bar and Fuse terminal shall be provided with Belleville washer and plain washer. Wherever required bimetallic washers to be provided
15	Phase & neutral Bus bar	Aluminium grade 19501 (H2) as per IS 5082
	Bus bar size in mm for 2500 A O/G	3600 sq.mm for Phase & Neutral
	2500A ACB Incoming	3600 sq.mm for Phase & Neutral
16	ACB O/G LINKS	3600 sq.mm for Phase & Neutral (Dimensions as per feasibility with Breaker palm connection)
	Bus bar color coding for R, Y, B & neutral	Heat shrinkable sleeves with color Red, Yellow, Blue & Black respectively
16 a	Bus Bar Heat shrinkable sleeves	Cross-linked Polyolefin (Bidder to specify thickness)
17	Main bus bar short circuit withstand capacity	Above 50kA for 1 sec
18	Permissible maximum temperature rise above ambient of 50°C	Busbar: 45 deg C
	Permissible maximum temperature rise above ambient of 50°C	Terminals: 65 deg C
19	Bus bar support insulators	As per IS13410 SMC / DMC, 1100V grade
20	Incoming Cable Size	4C 300 Sq.mm Al Ar XLPE
21	Outgoing Cable Size	4C 300 Sq.mm Al Ar XLPE

Rev No.	Prepared By & Date	Checked By & Date	Approved for Issue By & Date
R00	Yash M. Mane 	Ajay V. Potdar 	Ravindra M. Bhanage 
	11/01/2024	11/01/2024	11/01/2024

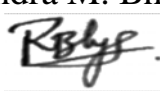
	22	Gland plate at panel bottom	HRCA MS 3mm thickness
	23	Cable termination clearance	600 mm minimum from gland plate & ACB
	24	Fuse Base	800 A
		Approved Make	L&T / Siemens / Schneider / GE Power Control / Jean Muller /Busmann / ABB
	25	Fuses (630 A)	HRC plug-in type gG (General Purpose, Fast acting fuse)
		Approved Make	L&T / Siemens / Schneider / GE Power Control / Jean Muller /Busmann / ABB
	26	CT's for 2500A Incoming Feeder	7 Nos. Single resin cast. a) 3 nos dual core CT's of ratio 2500/5A <ul style="list-style-type: none"> • Core 1: Class 0.5 & 15VA burden – For MFM • Core 2: 5P20 & 15VA – For Ashida make O/C+E/F relay b) 3 nos single core CTs of ratio 2500/5 A, Class 0.5 & 15 VA for Energy meter (Energy meter is not in bidder scope) c) 1 no single core CT of ratio 2500/5A, 5P20 & 15 VA for Neutral unbalance protection Approved Make of CTs: Reco/Newtek/Pragati/Kappa/ECS/Adcon
	27	TTB for Metering	Front connection, Screw Type 3 Phase 4 Wire, 4SF, 50 A, DAV/IMP make
	28	Wiring convention for TTB	Incoming from Bottom Side & Outgoing to Meter from Top side
	29	Multifunction Digital meter	Should be communicable on Modbus RS 485
	30	Earth Fault protection relay (NEF)	Alstom make CDG11 self-powered. Relay type is normal inverse with 3 Sec with E/F setting of 0.5 to 2 A
	31	Earthing Hardware	a) Earthing Nut and Bolt shall be M12 SS b) Washers shall be with Hot Dip Galvanized with 80 micron Galvanisation or Alu-Zinc coating.
	31a	Panel Earthing	Earthing provision to be provided on both sides with 50 mm extension of main Earth Bus Bar.
	32	Clearance between live parts	Phase - phase -Minimum 25 mm & Phase - earth - Minimum 20 mm
	33	Distance between each fuse outlet	Centre to Centre - 150mm (Minimum)

Rev No.	Prepared By & Date	Checked By & Date	Approved for Issue By & Date
R00	Yash M. Mane 	Ajay V. Potdar 	Ravindra M. Bhanage 
	11/01/2024	11/01/2024	11/01/2024

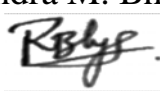

	34	Distance between fuse outlet & panel surface	125 mm (Minimum)
	35	Control terminals for CTs	Stud type with disconnecting facilities
	36	Control terminals for Voltage & other circuits	Stud type
	37	Illumination and Indicating Bulb	LED
	38	Continuous rated operating voltage	440 volt +/- 10%
	39	High voltage withstand capacity	2000 volt at 50 Hz for 1minute
	40	Insulation resistance ph-ph & ph-earth	Minimum 10M Ω with 500V Megger
	41	Labels & name plates	As per Specifications
	42	Surface preparation for painting	Sand blasting or 7 tank process
	43	Painting	Sand blasting or 7 tank process. Light grey shade No 631 of IS-5 Powder coated epoxy paint min thickness 120 micron
	44	Power Supply Socket	5A/15A Plug point socket to be provided
	45	Breaker Barrier	Breaker must have a metallic removable sheet from the front side which will act as a barrier between operator and the breaker. Provision must be given for breaker operation to be done through this barrier.
	46	Branding Plate	All supplied Units shall be fitted with engraved metallic logo of Tata Power on the front side. The Tata Power Co Ltd to be mentioned below the logo with clear font and Dimension 12*12 Inches. * Refer Annexure 2
	47	Panel Dimensions (Min depth of 900 mm)	L X D X H (For 6 W & 8W)
	48	Numerical Relay	Ashida (ADR 241S) with 4 Element
	49	Bus-bar phase barriers/ Phase separators (R-Y & Y-B)	FRP insulating sheet - (to be placed near to the phase bus-bar) (min 3 mm thickness) shall be provided between bus-bars, so as to ensure that there is no accidental contact with any live parts. (65 mm width)

Rev No.	Prepared By & Date	Checked By & Date	Approved for Issue By & Date
R00	Yash M. Mane 	Ajay V. Potdar 	Ravindra M. Bhanage 
	11/01/2024	11/01/2024	11/01/2024



5.0

**GENERAL
CONSTRUCTION**

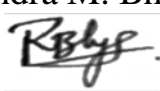
- 1) The feeder pillar frame shall be fabricated using suitable mild steel structural section or pressed and shaped Cold Rolled Closed Annealed (CRCA) sheet of thickness 3 mm.
- 2) Frames shall be enclosed by CRCA sheet of thickness 3mm, smoothly finished, levelled and free from flaws. Doors and cover shall be made of CRCA sheet of thickness not less than 2.5mm. Stiffeners shall be provided, wherever necessary. Gland plates shall be of Hot Rolled Closed Annealed (HRCA) thickness not less than 3 mm. alternatively gland can also be provided between two angles so that removal of gland is easy. The dimension of base frame should be 75mm X 40mm X 5 mm.
- 3) The panel shall be of metal enclosed and outdoor type, support frame mounted type with canopy of adequate slope to avoid water accumulation. Degree of protection shall be IP 54.
- 4) Breaker compartment and fuse compartment should be separated by metallic sheet; the same should be split suitably in order to avoid local heating due to eddy currents generated by three phase bus bars crossing through the same sheet. The breaker compartment should be in center of panel & Outgoings shall be on both the sides of breaker compartment.
- 5) The panel shall be of dust and vermin proof construction and of self-cooled design with adequate louvers on sides and top portion. The louvers shall have fine wire mesh made of brass. The minimum depth of panel shall be 900 mm.
- 6) Labels on the front and rear indicating the panel designation, phase marking and danger signs shall be provided. Single Line Diagram & feeder details shall be engraved and pasted on inside of panel.
- 7) Danger boards shall be provided in local languages on the Hylam sheet below breaker and on front & rear cover with red background and with white letters.
- 8) Hinged doors of lift off type, with concealed type with brass type hinges and captive screws shall be provided on the front side & Back side. Adequate numbers of door hinges shall be provided and should be durable and easy in operation. All doors shall be provided with padlocking facility. The design of doors should permit inter-changeability. The back-side doors shall have nut and bolt arrangement. All Hinged doors shall be connected to the earth terminal with 2.5 Sq.mm braided copper wires.
- 9) Cable entry facilities at bottom of panel and removable gland plates of size suitable to accommodate incoming & outgoing cables of sizes, 4 Core 300 Sq mm 1.1 KV XLPE Cable, shall be provided at required locations.
- 10) Distance between Gland plate and cable termination of Air Circuit Breaker should be minimum 600mm.
- 11) The panel shall be provided with gasket all around the perimeter of covers, gland plates, removable covers and doors.
- 12) ACB termination shall be with tinned copper or tinned aluminium Bus Bar. Wherever required bimetallic washer to be provide, if bare copper terminal is provided.

Rev No.	Prepared By & Date	Checked By & Date	Approved for Issue By & Date
R00	Yash M. Mane 	Ajay V. Potdar 	Ravindra M. Bhanage 
	11/01/2024	11/01/2024	11/01/2024

- 13) Busbars shall be of aluminium with Bakelite shrouding, rated for 2500 A, 50 kA for 1 sec and shall have adequate cross section to carry the rated continuous and short time current. Main Bus bar should be continuous/ without any joint. All bus bars, bus taps and joints shall be PVC taped. Neutral bus bar shall be provided on read side & rated for full bus bar rating.
- 14) The ACBs shall be mechanical operated fixed type 3 Pole with shunt trip coil without any microprocessor protection release. Ashida make (ADR41S) relay to be provided for tripping the breaker with Overcurrent & earth fault protection. Spare ACB contacts for shunt trip should be provided.**
- 15) All fuses shall be of the HRC cartridge type mounted on plug-in type fuse bases having a prospective current of not less than 80 kA.
- 16) Phase to phase clearance of 25mm and Phase to Neutral / Earth clearance of 20mm shall be provided in the panel.
- 17) Distance between centre to centre should be minimum 150 mm between each fuse outlet and 125 mm between fuse outlet and body of panel to be maintained.
- 18) The panel shall be provided with two separate earthing terminals connected to earth bus.
- 19) All instruments shall be connected to the earth terminal using 650V grade PVC insulated 2.5 sq mm stranded tinned copper earthing conductor. All Earthing should be routed properly along with body of panel.
- 20) All hinged doors, Covers, Gland Plates shall be connected to the earth terminal, with the help of braided copper conductors of adequate size. Flat earth bus should be protruded out for connection of external earth
- 21) Eyebolt of suitable sizes shall be provided for lifting arrangements.
- 22) All wiring shall be carried out with 650V grade PVC insulated stranded copper conductors of adequate sizes to suit the rated circuit current.
- 23) The panel shall be powder coated with light shade grade no 631 of IS 5.
- 24) Required number of foundation bolts shall be supplied with the panel.
- 25) Control fuses with control terminals for external cable connections shall be in the breaker chamber only.
- 26) The control terminals shall be as follows:
- Stud type with disconnecting facilities for CT circuits
 - Stud type for voltage and other circuits.
- 27) Fuse bases shall have adequate contact surface with the bus bars provided to ensure that no local heating takes place.
- 28) Lighting System in Feeder Pillar should be LED based.

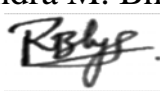
Rev No.	Prepared By & Date	Checked By & Date	Approved for Issue By & Date
R00	Yash M. Mane 	Ajay V. Potdar 	Ravindra M. Bhanage 
	11/01/2024	11/01/2024	11/01/2024

6 Way LT Panel: Representative GA drawing & SLD-

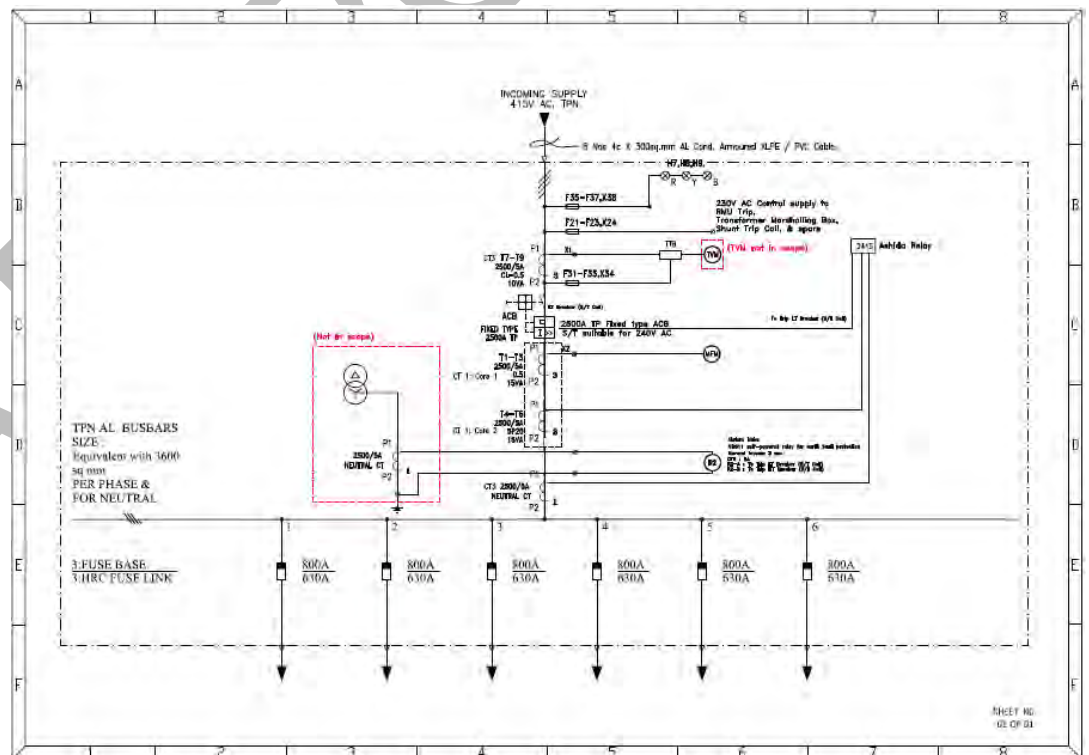
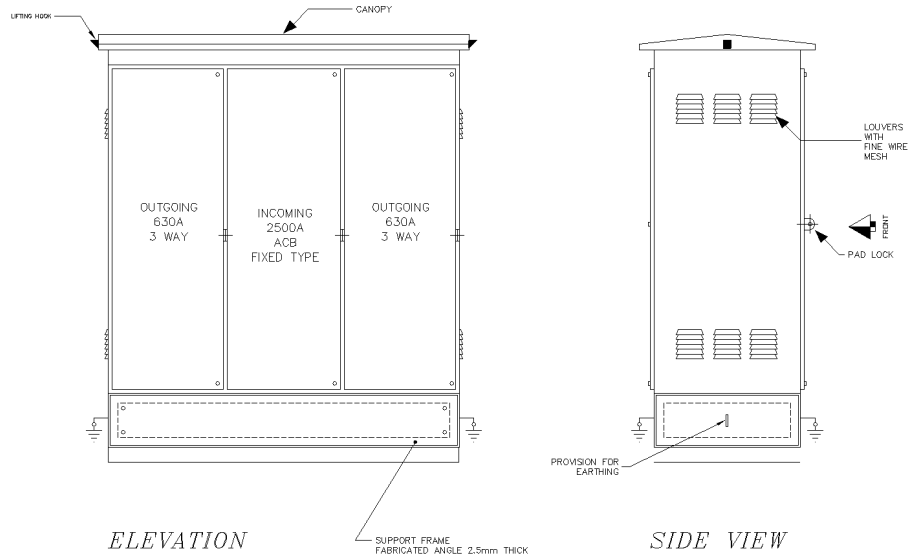

Rev No.	Prepared By & Date	Checked By & Date	Approved for Issue By & Date
R00	Yash M. Mane 	Ajay V. Potdar 	Ravindra M. Bhanage
	11/01/2024	11/01/2024	11/01/2024

8 Way LT Panel: Representative GA drawing & SLD-

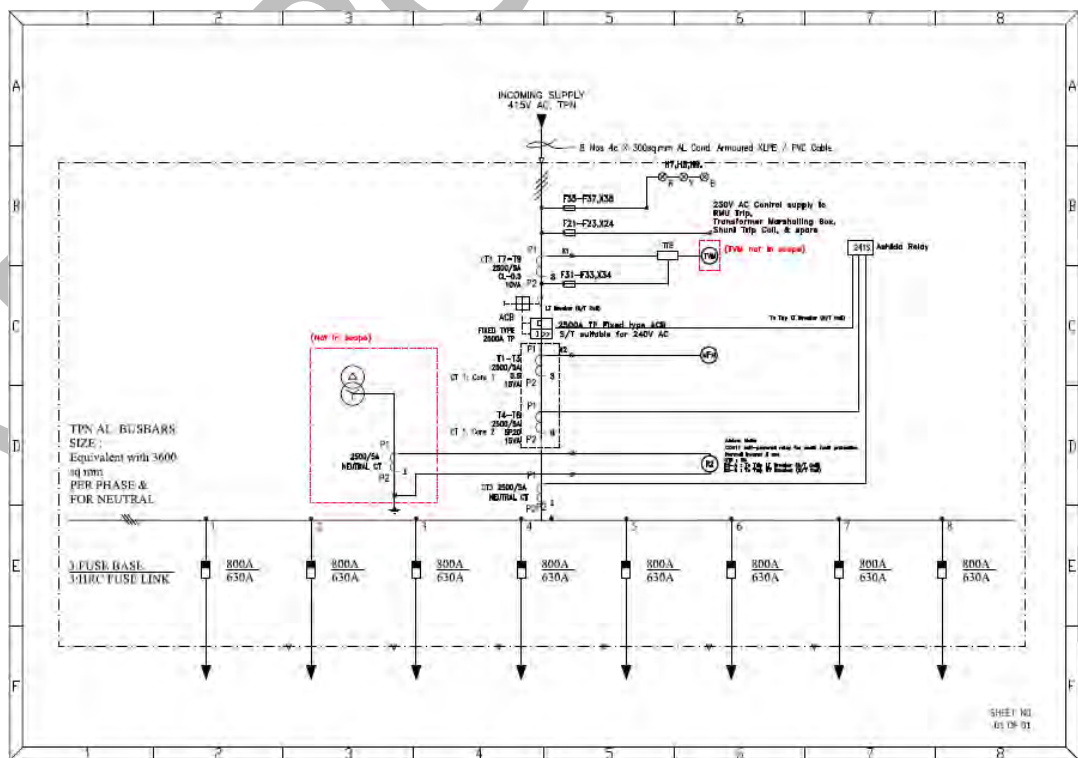
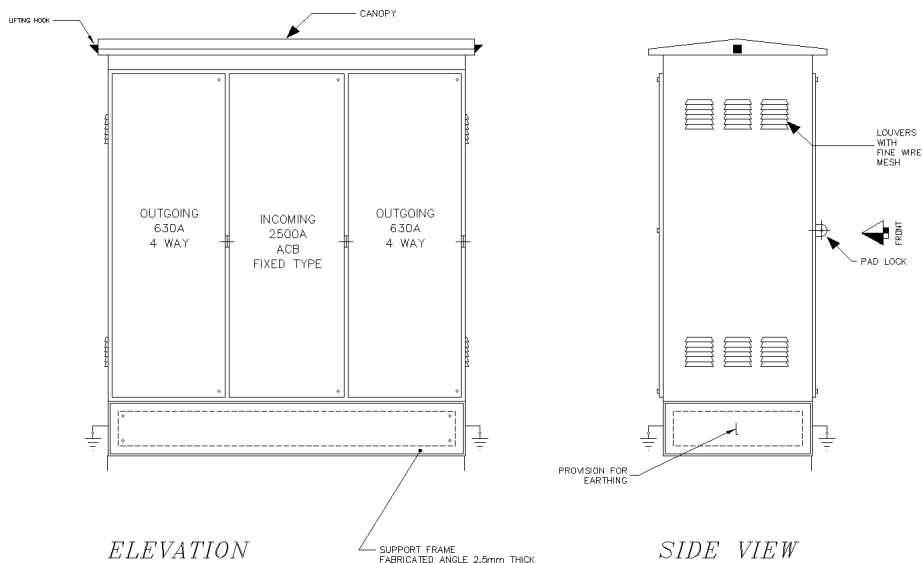

Rev No.	Prepared By & Date	Checked By & Date	Approved for Issue By & Date
R00	Yash M. Mane 	Ajay V. Potdar 	Ravindra M. Bhanage
	11/01/2024	11/01/2024	11/01/2024

Control Wiring Diagram:

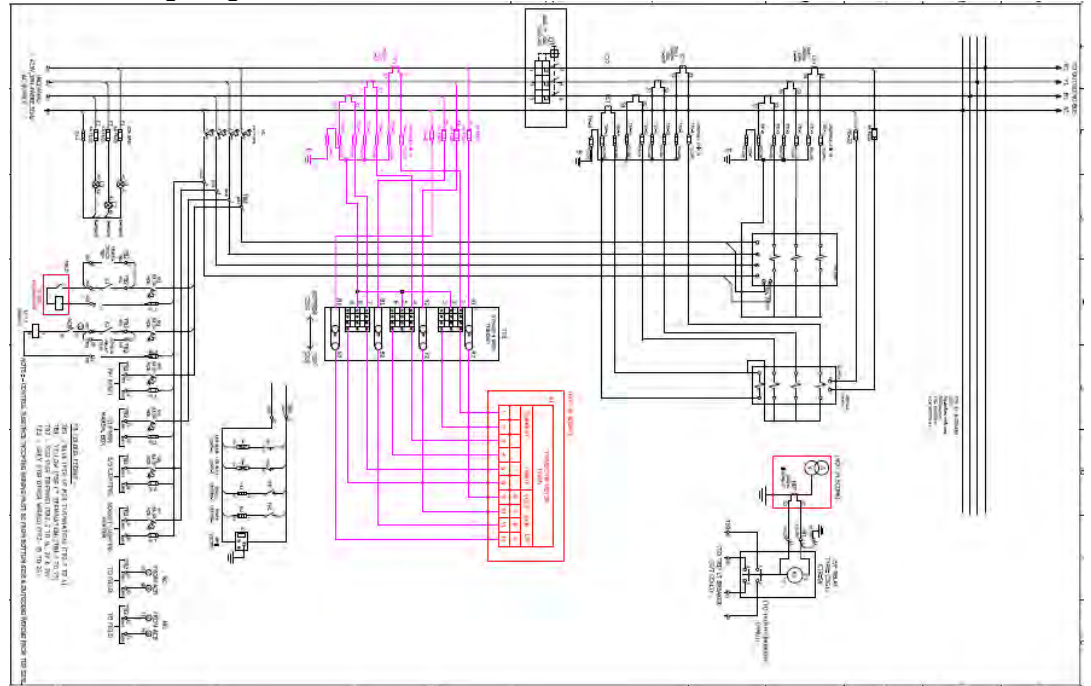

- a) The LT Panel should be 6 or 8-way type having 6 or 8 Nos. outlets per phase respectively as per tender requirement.
- b) Material Quality Plan, general arrangement drawing and single line diagram of the feeder pillar to be approved before manufacturing.
- c) Adequate cable termination shall be provided as follows

Sr. No.	TYPE	UoM	No. of Cable	Description
1	2500A Incomers	1No.	8	1.1KV, 4C, 300 sqmm AL cond. Armoured XLPE/PVC Cable
2	6 Way Panel 630 A Fuse Outgoing	6 No. Per outgoing	2	1.1KV, 4C, 300 sqmm AL cond. Armoured XLPE/PVC Cable
3	8 Way Panel 630 A Fuse Outgoing	8 no. Per outgoing	2	1.1KV, 4C, 300 sqmm AL cond. Armoured XLPE/PVC Cable

- d) 2500A Incomer shall be provided with resin cast CTs of ratio 2500/5A for metering & protection.
 3 nos dual core CT 2500A/5A, Core 1: 0.5 CI, Core 2: 5P20, 15 VA, to be used for MFM.
 3 nos single core CT 2500A/5A, 0.5, 15 VA, to be used for Energy metering.
 1 no single core CT 2000A/5A, 5P20, 15 VA, to be used for neutral unbalance protection.

5.1 Specific Requirements

Rev No.	Prepared By & Date	Checked By & Date	Approved for Issue By & Date
R00	Yash M. Mane 	Ajay V. Potdar 	Ravindra M. Bhanage
	11/01/2024	11/01/2024	11/01/2024

- e) All CT termination should be round plug type. No CT shorting arrangement to be provided. (As per SLD)
- f) Secondary wiring shall be carried out with 1.1KV grade PVC insulated stranded copper conductor of 2.5 Sq. mm for CT circuits and 2.5 Sq. mm for PT and other circuits. All wires will be colour coded.

Sr. No.	Equipment	Color	Nomenclature of TBs	Types of TBs
1.	TBs of 4 Pole MCB Termination	Blue	TB2	Droppable
2.	TBs for CT Termination	Yellow	TB1	Droppable
3.	TBs for Tripping	Red	TB2	Droppable
4.	All others	Default	TB2	Normal

- g) The feeder pillar panel shall be provided with Alstom Make CDG11 self-powered relay for earth fault protection. The relay type is normal inverse with 3 sec with E/F setting of 0.5 to 2 A.
- h) Test terminal box for Energy Metering should be Front Connection, Screw Type (4SF), 50 A to be provided and the convention of the wiring in the TTB should be Incoming from the bottom side and outgoing to Meter from top side. There must not be any partition between Relay & metering box in LV compartment. It should be single door compartment. No lugs shall be provided for wires to meter, TTB, and Fuses (PT secondary). Sealing arrangement to be provided for Energy Meters. Inspection glass (Transparent Toughened Glass) to be provided for viewing of meter.
- i) All Protection/ control wiring must terminate in LV compartment.
- j) Provision to be provided for mounting the energy meter with max dimensions as L x B x D: 360 x 200 x 200 mm (Energy meter will be supplied by TPC). The relay and energy meter shall be installed in the breaker compartment with suitable partitions. The relays shall be supplied by the vendor.
- k) The LT panel shall be equipped with shrouded type anti condensation space heaters with thermostat, internal light with switch & 5A/15A metal clad general-purpose plug socket.
- l) The following separate control circuit 20A, 4 pole MCB duly wired up to terminal block for purchaser's use shall be provided before the circuit breaker in feeder pillars leading to following single pole MCB with neutral links (refer SLD):

Phase and neutral for 230V supply to RMU. (6A)

Phase and neutral for 230V supply to Transformer marshalling box. (6A)

Phase and neutral for external shunt trip coil (6A)



Phase and neutral for FPI reset (6A)

Separate 16A, DP MCB duly wired for Auxiliary supply for LT panel for following purpose,

Phase and neutral for substation lighting (6A)

Phase and neutral for Socket (15A)/ Heater circuit

Phase and neutral for Ashida overcurrent relay (4A)

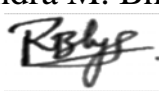
Rev No.	Prepared By & Date	Checked By & Date	Approved for Issue By & Date
R00	Yash M. Mane 	Ajay V. Potdar 	Ravindra M. Bhanage 
	11/01/2024	11/01/2024	11/01/2024

m) The following separate control fuses with neutral links duly wired out to a set of stud type link terminals for purchaser's use shall be provided before the circuit breaker in feeder pillars Control fuse Incoming wiring must be from bottom side & Outgoing wiring from top side. (refer SLD):

Three phase and neutral for metering circuit.

Three Phase and neutral for indication lamp

n) Locking should be of welded type. Earthing jumpers to be provided for all the doors. Louvers with stainless steel wire mesh to be provided on body side and cover plate.

o) Makes of various bought out items shall be limited to the following:

Sr. No.	Items	Approved Make
1	ACB	L&T/C&S/Siemens/Schneider/ABB/Eaton
2.	CT	Reco/Newtek/Pragati/Kappa/ECS/Adcon

p) Flexible copper braiding should be provided on the doors. Neutral bus shall be connected with earth bus. All control cable should be multi stranded and FRLS. CT ISF should be less than or equal to 5. Close and Open status of the breaker should be available on SCADA through spare auxiliary contact and on LT panel through LED Lamp.



q) The fuses provide should be of knife type and same should be removable with the help of fuse puller. There shall be no obstruction during removal of outgoing fuses by fuse puller.

r) The safety locking facility to be provided for putting three nos. of safety locks.

s) Panel minimum width in mm: 900 mm

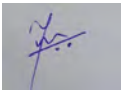

t) The breaker manufacturer to provide the complete support in terms of training; hand holding to our Testing and O&M staff. The breaker manufacturer to give the support service for next 10 years.

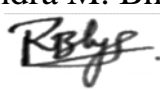
u) The robust isolating arrangement in the OG fuse compartment to be made.

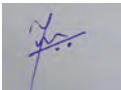

Rev No.	Prepared By & Date	Checked By & Date	Approved for Issue By & Date
R00	Yash M. Mane 	Ajay V. Potdar 	Ravindra M. Bhanage 
	11/01/2024	11/01/2024	11/01/2024

The Tata Power Company Limited		TECHNICAL SPECIFICATION OF 6 Way & 8 Way 2500 A LT Panel
ENSE-DS-2030-R00		Date of Issue: 11/01/2024

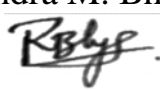
6.0	NAME PLATE AND MARKING	<p>6.1 Name plate- On front door top left side-showing</p> <ol style="list-style-type: none"> 1) Purchaser name & PO number. 2) Manufacturer name 3) Month / year of manufacturing 4) 'Property of Tata Power' <p>6.2 Marking for panel earth stud- Black letter 'E', on riveted Al label</p> <p>6.3 Danger board in English & local language, riveted on doors- White colour background with red lettering on 1.6mm thick Al plate.</p> <p>6.4 SLD shall be engraved & pasted on inside of door.</p> <p>6.5 CT Serial Nos., Ratio & ACB Serial Nos. to be written on doors with marker pen.</p> <p>6.6 Separate metallic name plate with Tata Power Logo of Dimension 12*12 Inches in clear font as shown in Annexure-2.</p>
7.0	TESTS	<p>All routine, acceptance & type tests shall be carried out in accordance with the relevant IS/IEC. Following tests shall be necessarily conducted on the 'Feeder Pillar' in addition to others specified in IS/IEC standards.</p> <p>*In case of any conflict on any technical particular, the stricter requirement mentioned in the relevant standard shall be valid.</p>
7.1	Type test	<p>Type test - Only type tested components – ACBs, Fuses, Insulators & aluminium bus bar shall be accepted. Following type test shall be carried out on the assembly.</p> <ol style="list-style-type: none"> a) Verification of temperature-rise limits – Clause 8.2.1 of IS 8623 b) Verification of dielectric properties – Clause 8.2.2 of IS 8623 c) Verification of short-circuits strength – Clause 8.2.3 of IS 8623 d) Verification of continuity of the protective circuit – Clause 8.2.4 of IS 8623 e) Verification of clearance and creepage distances – Clause 8.2.5 of IS 8623 f) Verification of mechanical operation – Clause 8.2.6 of IS 8623 f) Verification of degree of protection – Clause 8.2.7 of IS 8623
7.2	Routine test	<p>Acceptance & routine test- (Inspection test witness by purchaser as per approved Quality Assurance Plan)</p> <ol style="list-style-type: none"> 1) Visual inspection, dimension checks & paint thickness checks. 2) Bill of material check 3) Insulation resistance test 4) High voltage test 5) Operational check 6) Verification of dielectric properties 7) Tolerances on panel dimensions- Maximum +/- 5mm 8) No negative tolerance on bus bar dimensions & bus bar clearances 9) Stability test shall be conducted on all Panels, to ensure there shall be no tripping in case of unbalance current on earth fault function.

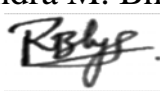

Rev No.	Prepared By & Date	Checked By & Date	Approved for Issue By & Date
R00	Yash M. Mane 	Ajay V. Potdar 	Ravindra M. Bhanage 
	11/01/2024	11/01/2024	11/01/2024

7.3	Acceptance test	<ol style="list-style-type: none"> 1) Visual inspection & dimensional check 2) Verification of clearance and creepage distance 3) Paint thickness check 4) Wiring checks 5) Insulation resistance test 6) HV test 7) Stability test on all Panels, to ensure there shall be no tripping in case of unbalance current on earth fault function. 8) 1 unit from 1st lot shall be tested for Temperature rise test with ACB and fuses. (Bidder to arrange for the same, either in factory or in external lab)
8.0	TYPE TEST CERTIFICATE	<p>The Bidder shall furnish the type test certificates for the tests as mentioned above as per the corresponding standards. Type Test to be conducted on similar Design/ rating panel. All the tests shall be conducted at CPR / ERDA/ NABL as per the relevant standards. Type test should have been conducted in certified Test Laboratories during the period not exceeding 10 years from the date of opening the bid.</p> <p>Type tests shall have been conducted in certified Test laboratories during the period not exceeding 10 years from the date of opening the bid. In case if type test conducted beyond 10 years then bidder to certify on letter head of parent OEM that no design change & no manufacturing plant change occurred from type tested product.</p> <p>In the event of any discrepancy in the test reports, i.e. any test report not acceptable or any/all type tests (including additional type tests, if any) not carried out, same shall be carried out without any cost implication to TATA POWER.</p>
9.0	PRE-DISPATCH INSPECTION	<p>The Material shall be subject to inspection by a duly authorized representative of the TATA POWER COMPANY. Inspection may be made at any stage of manufacture at the discretion of the Purchaser and the equipment, if found unsatisfactory as to workmanship or material, the same is liable to rejection. Bidder shall always grant free access to the places of manufacture to TATA POWER COMPANY `s representatives when the work is in progress. Inspection by the TATA POWER COMPANY or its authorized representatives shall not relieve the Bidder of his obligation of furnishing equipment in accordance with the specifications. TATA POWER COMPANY authorized representatives shall have the right to inspect the design, materials and workmanship and to report thereon, at any stage of manufacture, if found necessary. All facilities shall be extended to our representatives for witnessing the tests. Due notice shall be given to us to enable us to depute our representatives for stage inspection.</p> <p>Material shall be dispatched after specific MDCC (Material Dispatch Clearance Certificate) is issued by TATA POWER COMPANY.</p> <p>Five certified copies of all test certificates including type tests, sample test certificates shall be sent to us for our approval prior to dispatch of materials.</p> <p>Following documents shall be sent along with material</p> <ol style="list-style-type: none"> a) Test reports b) MDCC issued by TATA POWER COMPANY c) Invoice in duplicate d) Packing list e) Drawings & catalogue f) Delivery Challan g) Other Documents (as applicable).

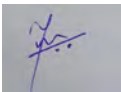

Rev No.	Prepared By & Date	Checked By & Date	Approved for Issue By & Date
R00	Yash M. Mane  11/01/2024	Ajay V. Potdar  11/01/2024	Ravindra M. Bhanage  11/01/2024

The Tata Power Company Limited		TECHNICAL SPECIFICATION OF 6 Way & 8 Way 2500 A LT Panel
ENSE-DS-2030-R00		Date of Issue: 11/01/2024

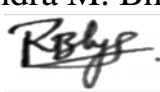
10.0	INSPECTION AFTER RECEIPT AT STORE	<p>The material received at TPC, Mumbai store shall be inspected for acceptance and shall be liable for rejection, if found different from the reports of the pre-dispatch inspection or any other parameters observed after delivery.</p> <p>The material should be delivered at TPC, Mumbai stores within 45 days from the date of manufacturing, same shall be checked during delivery and overdue material shall not be accepted. Bidders to plan the delivery accordingly.</p> <p>Bidders to attend and rectify the same at his own cost. The material shall be accepted in stores only after rectification of any observed flaw. The delay in rectification shall lead to any contractual penalty.</p> <p>Billing shall be processed only after acceptance of the material.</p>
11.0	GUARANTEE	<p>Bidder shall stand guarantee towards design, materials, workmanship & quality of process / manufacturing of items under this contract for due and intended performance of the same, as an integrated product delivered under this contract.</p> <p>In the event any defect is found by the TATA POWER COMPANY up to a period of at least 12 months from the date of commissioning or 24 months from the date of last supplies made under the contract whichever is later, (the time scale of 12/24 months could be enhanced subject to mutual agreements) Bidder shall be liable to undertake to replace/rectify such defects at its own costs, within mutually agreed time frame, and to the entire satisfaction of the Purchaser, failing which the TATA POWER COMPANY will be at liberty to get it replaced/rectified at Bidder's risks and costs and recover all such expenses plus the Purchaser's own charges (@ 20% of expenses incurred), from the Bidder or from the " Security cum Performance Deposit" as the case may be.</p> <p>In case of GP failure, BA shall report at site within 48 hours from intimation and arrange for rectification of fault within a mutually agreed time. In case rectification at site is not possible then alternative arrangement (replacement) to be made by BA within 15 days of intimation of failure.</p> <p>Bidder shall further be responsible for 'free replacement' for another period of THREE years from the end of the guarantee period for any 'Latent Defects' if noticed and reported by the Purchaser.</p>
12.0	PACKING AND TRANSPORT	<p>Bidder shall ensure that the item covered under this specification shall be packaged for rail/road transport in a manner so as to protect the equipment from damage in transit.</p> <ol style="list-style-type: none"> 1) Packing protection- Against shocks, vibration & corrosion, damages during transportation 2) Packing identification labels, to show purchaser name, PO number, quantity of panels, Panel type, Manufacturer serial number 3) Handling instruction- To be marked on packing boxes. 4) Bidders should prefer to use recyclable & environmentally friendly materials for packing. 5) No single use plastic to be used. 6) Packing should be done with environment friendly recyclable materials.
13.0	TENDER SAMPLE	Not Applicable

Rev No.	Prepared By & Date	Checked By & Date	Approved for Issue By & Date
R00	Yash M. Mane 	Ajay V. Potdar 	Ravindra M. Bhanage 
	11/01/2024	11/01/2024	11/01/2024

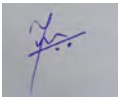
14.0	QUALITY CONTROL	<p>The Bidder shall submit with the offer Quality assurance plan indicating the various stages of inspection, the tests and checks which will be carried out on the material of construction, components during manufacture and bought out items and fully assembled component and equipment after finishing. As part of the plan, a schedule for stage and final inspection within the parameters of the delivery schedule shall be furnished.</p> <p>TATA POWER COMPANY shall reserve the sole rights for the type test of a random sample from the lot and in case of any discrepancy or deviation from the Type test certificates submitted along with the Bid; the complete Lot shall be rejected.</p> <p>TATA POWER COMPANY representative or its nominated representative shall have free access to the Bidder's works to carry out inspections.</p> <p>If anything missing in QAP and required as per other clauses of this document, bidder is liable to perform the same without cost implication.</p>
15.0	MINIMUM TESTING FACILITIES	<p>Bidder shall have adequate in-house testing facilities for carrying out all routine tests & acceptance tests as per relevant International / Indian standards and as specified above.</p>
16.0	MANUFACTURING ACTIVITIES	<p>The successful bidder will have to submit first GTP & Drawing with 7 days from placement of outline agreement for approval and complete the approval process within 14 days of outline agreement. The date of Code -2/ Code-1 approval given by TATA Power will be treated as first day for assessment of LD (if applicable).</p>
17.0	SPARES, ACCESSORIES, AND TOOLS	<p>Keys of door</p>
18.0	DRAWING AND DOCUMENTS	<p>Following drawings and documents shall be prepared based on TATA POWER COMPANY specifications and statutory requirements and shall be submitted with the bid. All the documents & drawings shall be in English language</p> <ul style="list-style-type: none"> a) Completely filled in Technical Particulars b) General description of the equipment and all components including brochures. c) General arrangement drawing. d) Bill of material e) Experience List f) Type test certificates g) Any other technical document, if required
19.0	SCHEDULE "A" GUARANTEED TECHNICAL PARTICULARS	<p>Bidders to comply for all above requirement of specifications clauses & submit signed and stamp copy as technical compliance document.</p>

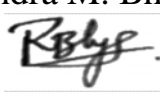
Rev No.	Prepared By & Date	Checked By & Date	Approved for Issue By & Date
R00	Yash M. Mane  11/01/2024	Ajay V. Potdar  11/01/2024	Ravindra M. Bhanage  11/01/2024

20.0

**SCHEDULE
"B" DEVIATIONS**

The bidders shall set out all deviations from this specification, Clause by Clause in this schedule. Unless specifically mentioned in this schedule, the tender shall be deemed to confirm the purchaser's specifications.

(TO BE ENCLOSED WITH THE BID)

All deviations from this specification shall be set out by the bidders, clause by Clause in this schedule. Unless specifically mentioned in this Schedule, the tender shall be deemed to confirm the purchaser's specifications:



Sr.No.	Clause No.	Details of deviation with justifications

We confirm that there are no deviations apart from those detailed above.

Seal of the Company

Signature :

Designation :

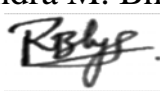
Rev No.	Prepared By & Date	Checked By & Date	Approved for Issue By & Date
R00	Yash M. Mane 	Ajay V. Potdar 	Ravindra M. Bhanage 
	11/01/2024	11/01/2024	11/01/2024



The Tata Power Company Limited		TECHNICAL SPECIFICATION OF 6 Way & 8 Way 2500 A LT Panel
ENSE-DS-2030-R00		Date of Issue: 11/01/2024

Annexure – 1

Inspection Testing Plan

1. Visual inspection & dimensional check
2. Verification of clearance and creepage distance
3. Paint thickness check
4. Wiring checks
5. Insulation resistance test
6. HV test
7. Stability test on all Panels, to ensure there shall be no tripping in case of unbalance current on earth fault function
8. 1 unit from 1st lot shall be tested for Temperature rise test with ACB and fuses. (Bidder to arrange for the same, either in factory or in external lab)

TATA POWER

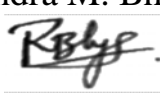
Rev No.	Prepared By & Date	Checked By & Date	Approved for Issue By & Date
R00	Yash M. Mane 	Ajay V. Potdar 	Ravindra M. Bhanage 
	11/01/2024	11/01/2024	11/01/2024

Annexure – 2

Tata power Branding Name plate -

Separate metallic name plate with Tata Power Logo of Dimension 12*12 Inches in clear font as shown below.

Relationship between the two marks- size

The Tata and Tata Power Marks are always used in conjunction with each other, never appearing in isolation on Tata Power communication.

The height of the letter T of Tata (T-height) is the basic measure for all sizes and proportions.

The rounded measure 2T in height, is separated from the Tata lettering by a distance of 1/2T.

The T height of both, the Tata and the Tata Power Marks is to be the same, except in exceptional cases on approval from the Corporate Communications team.





Relationship between the two marks- positioning

The two marks can appear stacked, which is the preferred placement, or linear, by the side of one another.

Centre aligned - Stacked (Preferred)

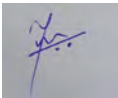

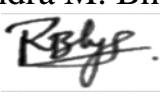

Rev No.	Prepared By & Date	Checked By & Date	Approved for Issue By & Date
R00	Yash M. Mane 	Ajay V. Potdar 	Ravindra M. Bhanage 
	11/01/2024	11/01/2024	11/01/2024

The Tata Power Company Limited		TECHNICAL SPECIFICATION OF 6 Way & 8 Way 2500 A LT Panel
ENSE-DS-2030-R00		Date of Issue: 11/01/2024

Annexure – 3

Reference drawings

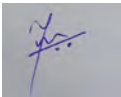
TATA POWER

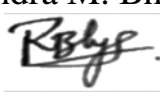
Rev No.	Prepared By & Date	Checked By & Date	Approved for Issue By & Date
R00	Yash M. Mane 	Ajay V. Potdar 	Ravindra M. Bhanage 
	11/01/2024	11/01/2024	11/01/2024

TO OUTGOING BUS
R1 Y1 B1 N1

TPN AL BUSBARS
SIZE:
Equivalent with area
3600 sq.mm
PER PHASE &
FOR NEUTRAL

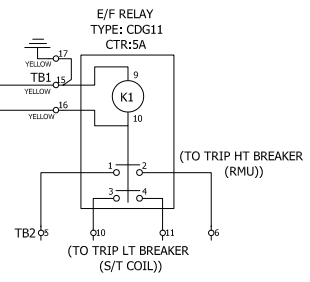
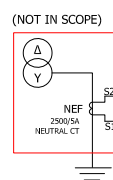

(NOT IN SCOPE)

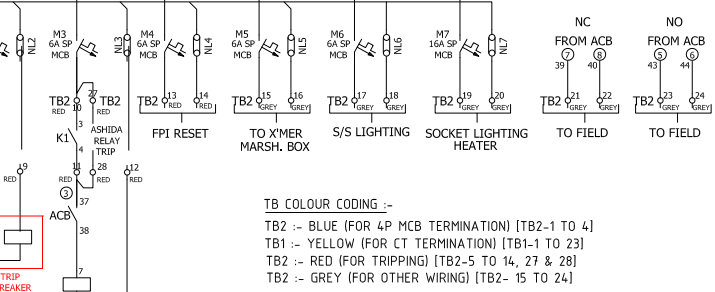
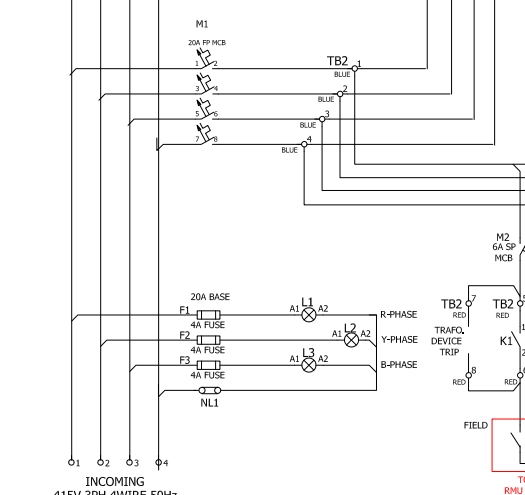
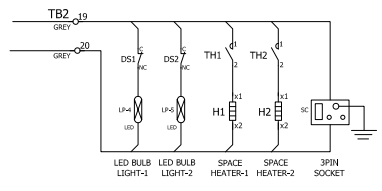
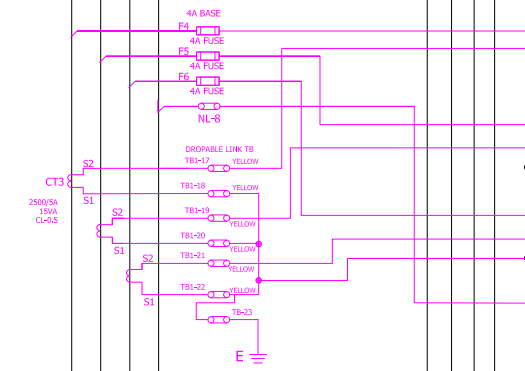
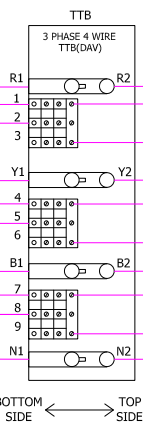
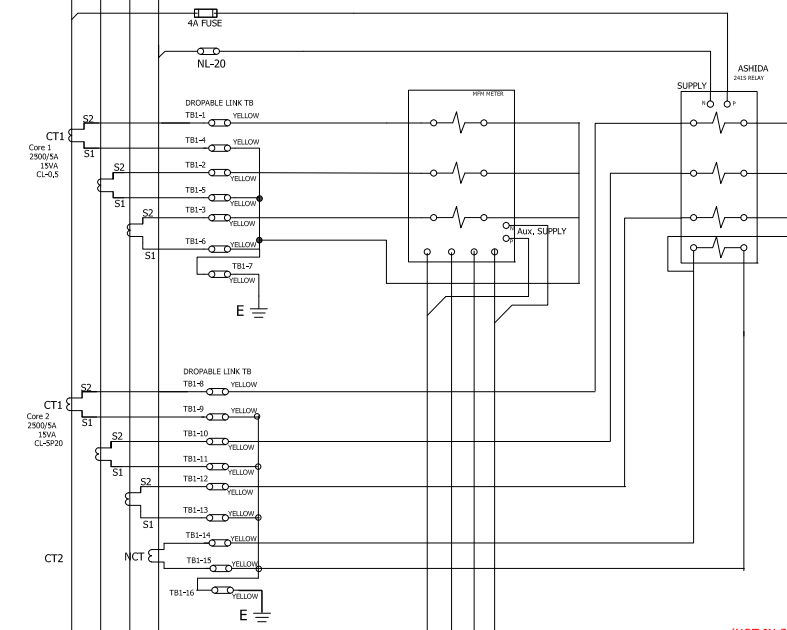
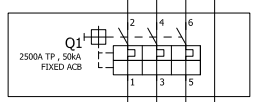
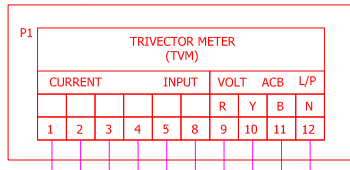

TB COLOUR CODING :-
TB2 :- BLUE (FOR 4P MCB TERMINATION) [TB2-1 TO 4]
TB1 :- YELLOW (FOR CT TERMINATION) [TB1-1 TO 23]
TB2 :- RED (FOR TRIPPING) [TB2-5 TO 14, 27 & 28]
TB2 :- GREY (FOR OTHER WIRING) [TB2- 15 TO 24]

NOTE :- CONTROL FUSE/MCB INCOMING WIRING MUST BE FROM BOTTOM SIDE & OUTGOING WIRING FROM TOP SIDE.

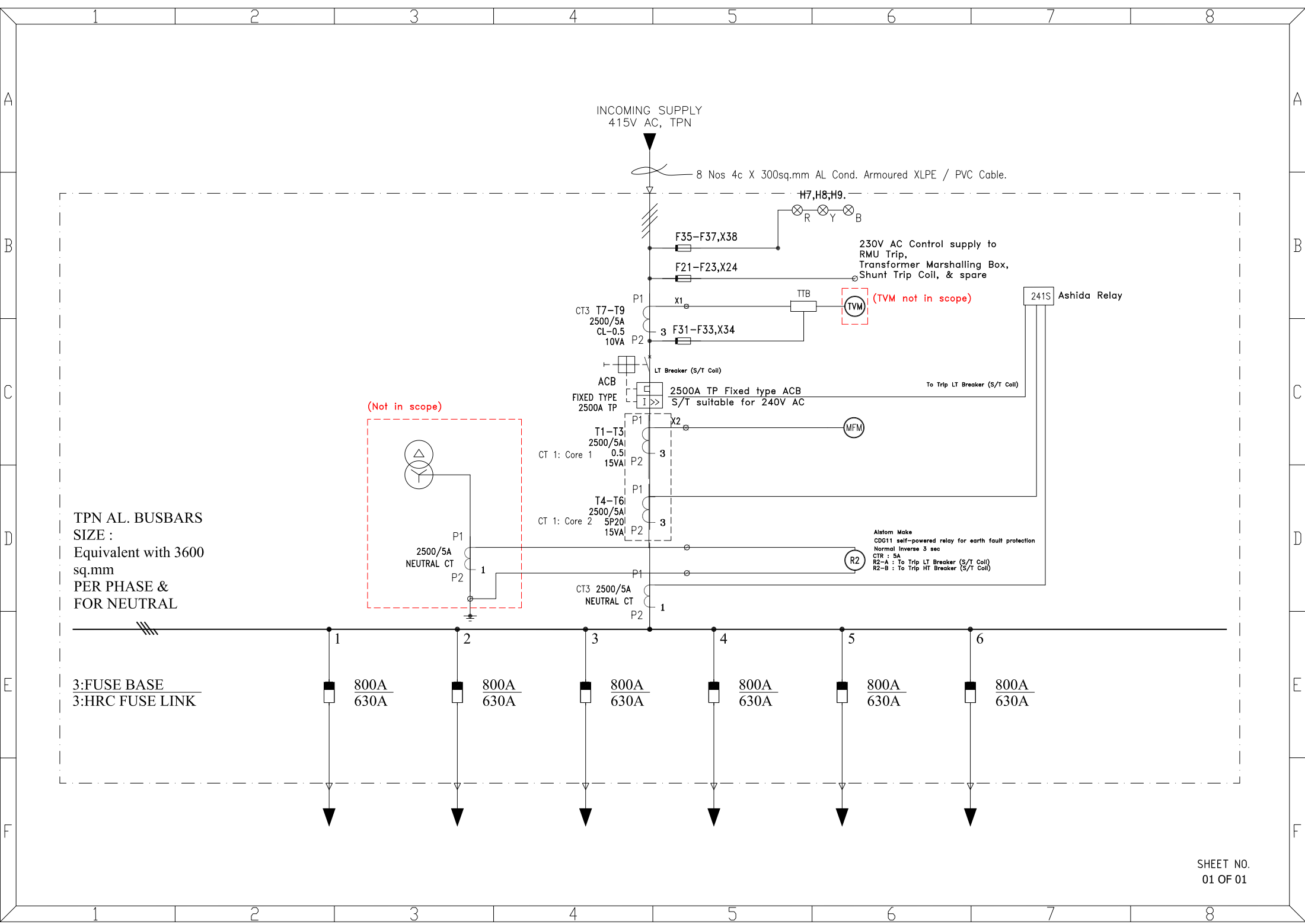

INCOMING SUPPLY
415V AC, TPN

8 Nos 4c X 300sq.mm AL Cond. Armoured XLPE / PVC Cable.

H7,H8,H9.

F35-F37,X38

F21-F23,X24

230V AC Control supply to
RMU Trip,
Transformer Marshalling Box,
Shunt Trip Coil, & spare

CT3 T7-T9
2500/5A
CL-0.5
10VA

P1
P2

X1

TTB

(TVM not in scope)

241S Ashida Relay

3 F31-F33,X34

LT Breaker (S/T Coil)

ACB
FIXED TYPE
2500A TP

2500A TP Fixed type ACB
S/T suitable for 240V AC

To Trip LT Breaker (S/T Coil)

(Not in scope)

T1-T3
2500/5A
0.5
15VA

P1
P2

X2

(MFM)

T4-T6
2500/5A
5P20
15VA

P1
P2

Alstom Make
CDG11 self-powered relay for earth fault protection
Normal Inverse 3 sec
CTR : 5A
R2-A : To Trip LT Breaker (S/T Coil)
R2-B : To Trip HT Breaker (S/T Coil)

(R2)

CT3 2500/5A
NEUTRAL CT

P1
P2

1

2500/5A
NEUTRAL CT

P1
P2

1

TPN AL. BUSBARS
SIZE :
Equivalent with 3600
sq.mm
PER PHASE &
FOR NEUTRAL

3:FUSE BASE
3:HRC FUSE LINK

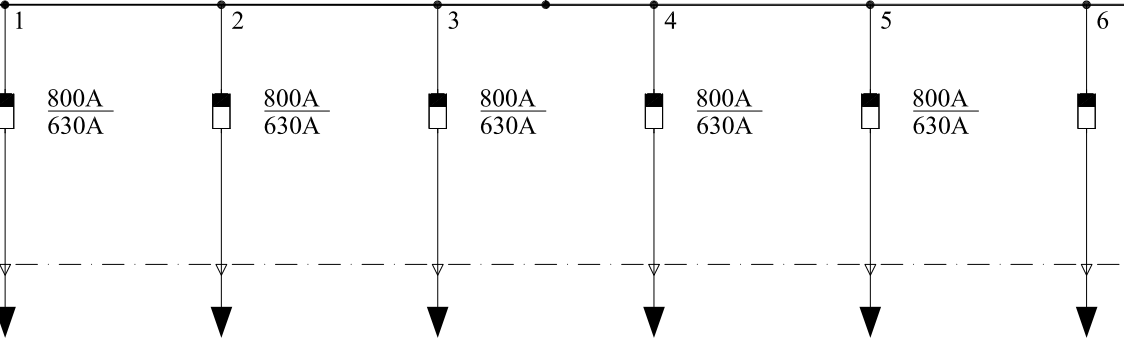

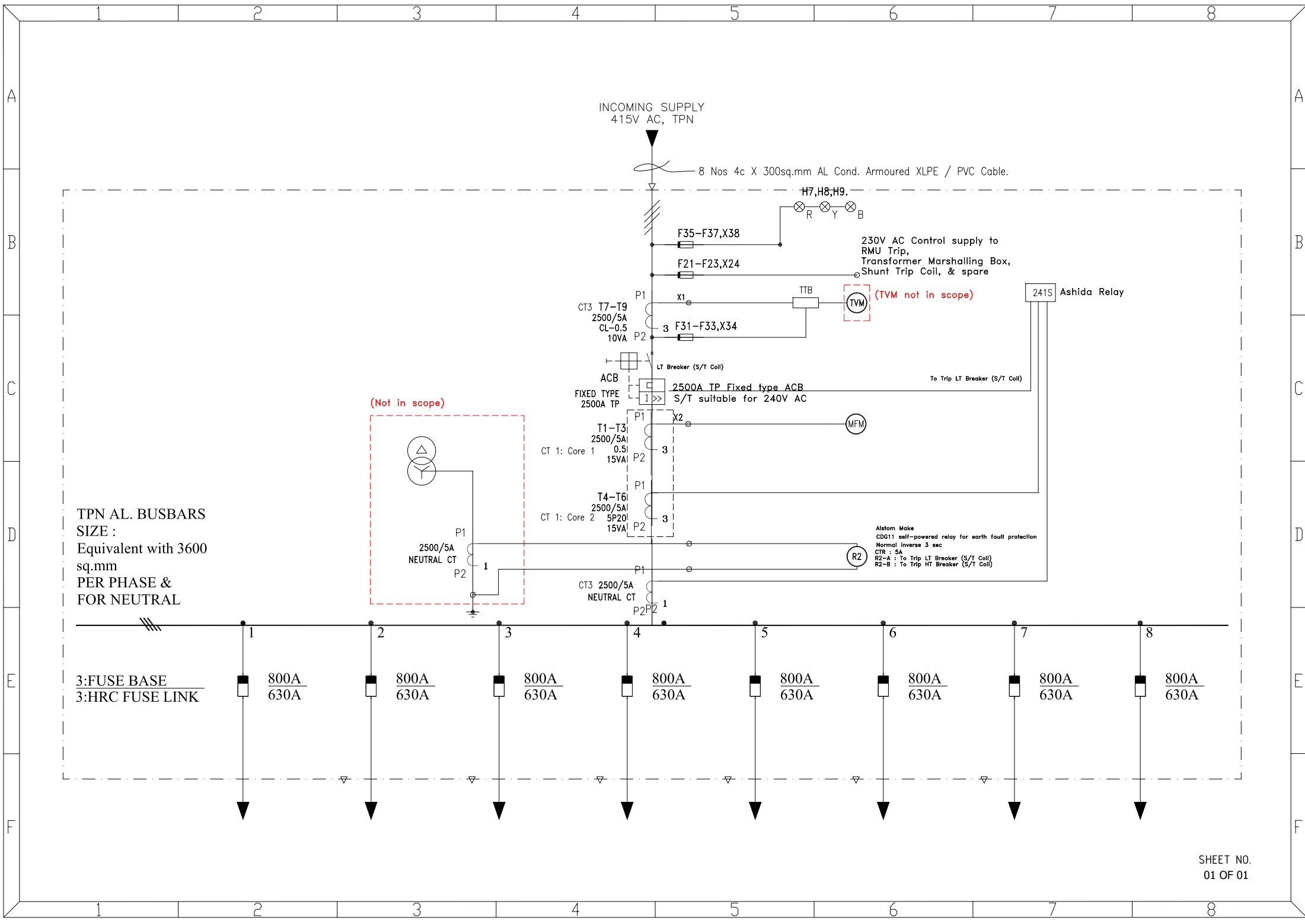

INCOMING SUPPLY
415V AC, TPN

8 Nos 4c X 300sq.mm AL Cond. Armoured XLPE / PVC Cable.

H7,H8,H9.

F35-F37,X38

F21-F23,X24

230V AC Control supply to
RMU Trip,
Transformer Marshalling Box,
Shunt Trip Coil, & spare

TTB

(TVM not in scope)

241S Ashida Relay

CT3 T7-T9
2500/5A
CL-0.5
10VA

F31-F33,X34

ACB
FIXED TYPE
2500A TP

2500A TP Fixed type ACB
S/T suitable for 240V AC

To Trip LT Breaker (S/T Coil)

(Not in scope)

T1-T3
2500/5A
0.5
15VA
CT 1: Core 1

T4-T6
2500/5A
5P20
15VA
CT 1: Core 2

Alstom Make
CDG11 self-powered relay for earth fault protection
Normal Inverse 3 sec
CTR : 5A
R2-A : To Trip LT Breaker (S/T Coil)
R2-B : To Trip HT Breaker (S/T Coil)

TPN AL. BUSBARS
SIZE :
Equivalent with 3600
sq.mm
PER PHASE &
FOR NEUTRAL

2500/5A
NEUTRAL CT

CT3 2500/5A
NEUTRAL CT

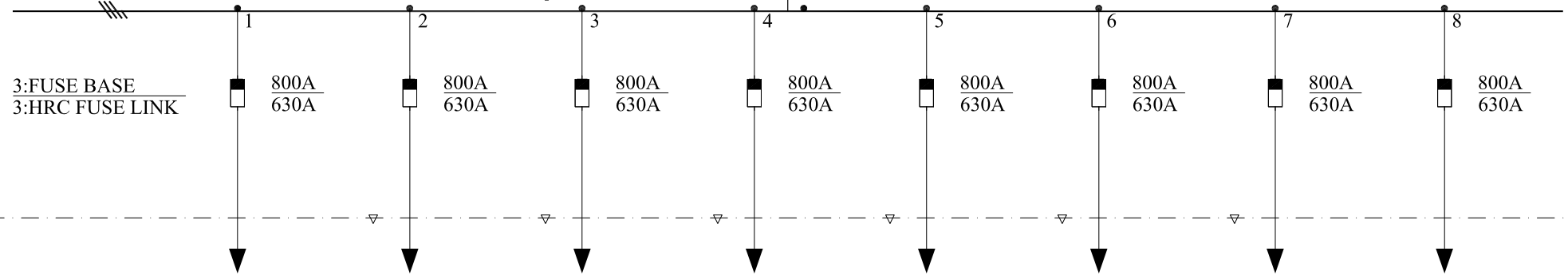

TECHNICAL SPECIFICATION

6 Way 1250 A LT Panel



The Tata Power Company Ltd.
Engineering Services (ENSE),
Distribution Division,
Senapati Bapat Marg,
Lower Parel,
Mumbai – 400013
Maharashtra



The Tata Power Company Limited		TECHNICAL SPECIFICATION OF 6 Way 1250 A LT Panel
ENSE-DS-2031-R00		Date of Issue: 11/01/2024

TECHNICAL SPECIFICATION COVER SHEET

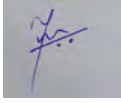
Document No: ENSE-DS-2031-R00

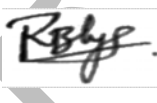
Document Title: Technical SPECIFICATION OF 6 Way 1250 A LT Panels

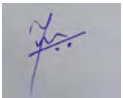

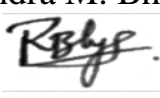
R00	ENSE-DS-2031-R00 (For Tendering Purpose)	11/01/2024	YMM		AVP		RMB	
R0	SPEC-NET-Feeder Pillar-1250A	17/09/21	MY	-sd-	AVP	-sd-	RK	-sd-
Rev No.	Remarks	Date	Initials	Sign	Initials	Sign	Initials	Sign
			Prepared By		Reviewed By		Approved & Issued By	

Rev No.	Prepared By & Date	Checked By & Date	Approved for Issue By & Date
R00	Yash M. Mane 	Ajay V. Potdar 	Ravindra M. Bhanage 
	11/01/2024	11/01/2024	11/01/2024

The Tata Power Company Limited		TECHNICAL SPECIFICATION OF 6 Way 1250 A LT Panel
ENSE-DS-2031-R00		Date of Issue: 11/01/2024

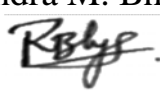

CONTENTS

	<u>PAGE NO</u>
1.0 SCOPE	4
2.0 APPLICABLE STANDARDS	4
3.0 CLIMATIC CONDITIONS OF THE INSTALLATION	5
4.0 GENERAL TECHNICAL REQUIREMENTS	5
5.0 GENERAL CONSTRUCTIONS	9
6.0 NAME PLATE & MARKINGS	15
7.0 TESTS, ROUTINE & ACCEPTANCE TESTS	15
8.0 TYPE TEST CERIFICATES	16
9.0 PRE-DISPATCH INSPECTION	16
10.0 INSPECTION AFTER RECEIPT AT STORE	17
11.0 GUARANTEE	17
12.0 PACKING AND TRANSPORT	17
13.0 TENDER SAMPLE	17
14.0 QUALITY CONTROL	18
15.0 MINIMUM TESTING FACILITIES	18
16.0 MANUFACTURING ACTIVITIES	18
17.0 SPARES, ACCESSORIES AND TOOLS	18
18.0 DRAWING AND DOCUMENTS	18
19.0 SCHEDULE "A" GUARANTEED TECHNICAL PARTICULARS	18
20.0 SCHEDULE "B" DEVIATIONS	19
+ ANNEXURE 1, 2 & 3	

Rev No.	Prepared By & Date	Checked By & Date	Approved for Issue By & Date
R00	Yash M. Mane 	Ajay V. Potdar 	Ravindra M. Bhanage 
	11/01/2024	11/01/2024	11/01/2024

The Tata Power Company Limited		TECHNICAL SPECIFICATION OF 6 Way 1250 A LT Panel
ENSE-DS-2031-R00		Date of Issue: 11/01/2024

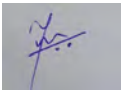
1.0 SCOPE	<p>This specification covers design, engineering, manufacture; shop testing, inspection, painting, packing, and supply of 415V, 1250 A LT Panel with 6 no Outgoing Feeders complete with all accessories for efficient and trouble-free operation of the distribution network for Tata Power Company Limited at Mumbai.</p> <p>It is not our intent to specify completely herein all details of design and construction of the equipment. However, the equipment shall conform in all respects to high standards of Engineering design and workmanship and shall be capable of performing in a manner acceptable to the purchaser (TPC) who will interpret the meaning of drawings and specification and shall be entitled to reject any work or material which in his judgement is not in full accordance therewith.</p> <p>All the bought-out items shall be of reputed make and shall be subject to approval by the PURCHASER (TPC) after award of contract.</p>																																				
2.0 APPLICABLE STANDARDS	<p>The equipment shall conform to this specification and latest revision of following codes with all amendments.</p> <table border="1" style="width: 100%; border-collapse: collapse;"> <thead> <tr> <th style="width: 5%;"></th> <th style="width: 25%;">Title</th> <th style="width: 70%;">Indian standard</th> </tr> </thead> <tbody> <tr> <td style="text-align: center;">1</td> <td>IS 8623</td> <td>Specification for low voltage switchgear</td> </tr> <tr> <td style="text-align: center;">2</td> <td>IS 12063/ IEC 60529</td> <td>Classification of degrees of protection provided by Enclosures of Electrical equipment</td> </tr> <tr> <td style="text-align: center;">3</td> <td>IS 5</td> <td>Color of ready mixed paints</td> </tr> <tr> <td style="text-align: center;">4</td> <td>IS 5082</td> <td>Wrought Aluminium & Al alloy plates & sheets for electrical application</td> </tr> <tr> <td style="text-align: center;">5</td> <td>IS 2705</td> <td>Current Transformers</td> </tr> <tr> <td style="text-align: center;">6</td> <td>IS 2551</td> <td>Danger Notice plates</td> </tr> <tr> <td style="text-align: center;">7</td> <td>IS 13703-2</td> <td>Low voltage fuses for voltage not exceeding 1000 V AC or 1500 V DC. Part 2 Fuses for use by authorized persons</td> </tr> <tr> <td style="text-align: center;">8</td> <td>IEC 255</td> <td>Protection Relays</td> </tr> <tr> <td style="text-align: center;">9</td> <td>IEC 801</td> <td>Control and monitoring</td> </tr> <tr> <td style="text-align: center;">10</td> <td>IEC 60947-2 /IS 13947-2</td> <td>Low Voltage Switchgear & control gear</td> </tr> <tr> <td style="text-align: center;">11</td> <td>IEC 60269</td> <td>Low Voltage Fuses</td> </tr> </tbody> </table> <p>In case of any conflict on any technical particular in the specification, the stricter requirement mentioned in the relevant standard shall be valid</p>		Title	Indian standard	1	IS 8623	Specification for low voltage switchgear	2	IS 12063/ IEC 60529	Classification of degrees of protection provided by Enclosures of Electrical equipment	3	IS 5	Color of ready mixed paints	4	IS 5082	Wrought Aluminium & Al alloy plates & sheets for electrical application	5	IS 2705	Current Transformers	6	IS 2551	Danger Notice plates	7	IS 13703-2	Low voltage fuses for voltage not exceeding 1000 V AC or 1500 V DC. Part 2 Fuses for use by authorized persons	8	IEC 255	Protection Relays	9	IEC 801	Control and monitoring	10	IEC 60947-2 /IS 13947-2	Low Voltage Switchgear & control gear	11	IEC 60269	Low Voltage Fuses
	Title	Indian standard																																			
1	IS 8623	Specification for low voltage switchgear																																			
2	IS 12063/ IEC 60529	Classification of degrees of protection provided by Enclosures of Electrical equipment																																			
3	IS 5	Color of ready mixed paints																																			
4	IS 5082	Wrought Aluminium & Al alloy plates & sheets for electrical application																																			
5	IS 2705	Current Transformers																																			
6	IS 2551	Danger Notice plates																																			
7	IS 13703-2	Low voltage fuses for voltage not exceeding 1000 V AC or 1500 V DC. Part 2 Fuses for use by authorized persons																																			
8	IEC 255	Protection Relays																																			
9	IEC 801	Control and monitoring																																			
10	IEC 60947-2 /IS 13947-2	Low Voltage Switchgear & control gear																																			
11	IEC 60269	Low Voltage Fuses																																			

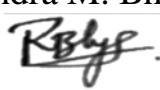
Rev No.	Prepared By & Date	Checked By & Date	Approved for Issue By & Date
R00	Yash M. Mane 	Ajay V. Potdar 	Ravindra M. Bhanage 
	11/01/2024	11/01/2024	11/01/2024

3.0

**CLIMATIC
CONDITIONS OF
THE
INSTALLATION**

1	Maximum ambient temperature	43 deg.C
2	Max. Daily average ambient temp	35 deg.C
3	Min Ambient Temperature	07 deg.C
4	Maximum Relative Humidity	100%
5	Minimum Relative Humidity	40%
6	Average No. of thunderstorm per annum	50
7	Average Annual Rainfall	2380mm
8	Average No. of rainy days per annum	115
9	Rainy months	June to Oct.
10	Altitude above MSL not exceeding	300 meters
11	Average Air Pressure	29.6-inch Hg

Atmosphere is generally laden with mild acid and dust suspended during dry months and subjected to fog in cold months. The design of the equipment and accessories shall be suitable to withstand seismic forces corresponding to an acceleration of 0.1g.

4.0

**GENERAL
TECHNICAL
REQUIREMENTS**

Sr. No	Item Description	Tata Power Requirement
1	Manufacturer	Name
		Manufacturer Address
		Contact telephone no
2	Breaker Rating (ACB)	1250A Manual Fixed Type without any microprocessor relay. 230V AC Shunt tripping coil to be provided.
	Model of ACB	The Model shall be such that current density in current carrying part shall be less than 3 A/sq.mm. (Bidder to mention the model)
	Approved Make	Schneider/ L&T/ Siemens/ C&S/ ABB/ Eaton
3	Main bus bar rating	1250 A
	Bus bar Size for Phase & Neutral	2000 sq.mm for Phase & Neutral
	Earth Bus	1 x 50 x 10 mm GI
4	Type of Installation	Indoor / Outdoor Type
5	No of Incoming feeders	Qty -1no. of 1250A ACB with 7 Nos of 4CX300 sq.mm Al Ar XLPE cables
6	No of outgoing feeders (6 Way)	Quantity - 5 Nos of 630A each with 2 no's of 4CX300 sq.mm Al Ar XLPE cables per O/G
7	Panel construction	CRCA sheet steel of thickness 3 mm
8	Panel enclosure class	IP54 - ingress protection

Rev No.

Prepared By & Date

Checked By & Date

Approved for Issue By
& Date

R00

Yash M. Mane

Ajay V. Potdar



Ravindra M. Bhanage

11/01/2024



11/01/2024

11/01/2024

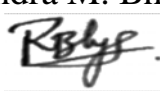

	9	Sheet steel thickness	Doors & Covers - 2.5mm, FRAME - 3mm
	10	Door type for front & rear access	Double door with rear door bolted
	11	Door hinges	Minimum three anti-theft type hinges self-locking type
	12	Padlocking facility	For front door
	13	Master key for all doors	Identical for all panels, 1 no./ panel to be provided
	14	Hardware & Fasteners	All Nuts, Bolts, Washers shall be Hot Dip Galvanized with 80 micron Galvanisation or Alu-Zinc coating. Bolts below 12 mm size shall be SS material.
	14a	Current Carrying part hardware	Each bolt on Bus Bar and Fuse terminal shall be provided with Belleville washer and plain washer. Wherever required bimetallic washers to be provided
	15	Phase & neutral Bus bar	Aluminium grade 19501 (H2) as per IS 5082
		Bus bar size in mm for 1250 A O/G	2000 sq.mm for Phase & Neutral
		1250A ACB Incoming	2000 sq.mm for Phase & Neutral
		ACB O/G LINKS	2000 sq.mm for Phase & Neutral (Dimensions as per feasibility with Breaker palm connection)
	16	Bus bar colour coding for R, Y, B & neutral	Heat shrinkable sleeves with colour Red, Yellow, Blue & Black respectively
	16 a	Bus Bar Heat shrinkable sleeves	Cross-linked Polyolefin (Bidder to specify thickness)
	17	Main bus bar short circuit withstand capacity	Above 50kA for 1 sec
	18	Permissible maximum temperature rise above ambient of 50°C	Busbar: 45 deg C
		Permissible maximum temperature rise above ambient of 50°C	Terminals: 65 deg C
	19	Bus bar support insulators	As per IS13410 SMC / DMC, 1100V grade
	20	Incoming Cable Size	4C 300 Sq.mm Al Ar XLPE
	21	Outgoing Cable Size	4C 300 Sq.mm Al Ar XLPE
	22	Gland plate at panel bottom	HRCA MS 3mm thickness

Rev No.	Prepared By & Date	Checked By & Date	Approved for Issue By & Date
R00	Yash M. Mane 	Ajay V. Potdar 	Ravindra M. Bhanage 
	11/01/2024	11/01/2024	11/01/2024

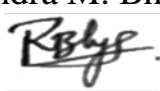
	23	Cable termination clearance	600 mm minimum from gland plate & ACB
	24	Fuse Base	800 A
		Approved Make	L&T / Siemens / Schneider / GE Power Control / Jean Muller /Busmann / ABB
	25	Fuses (630 A)	HRC plug-in type gG (General Purpose, Fast acting fuse)
		Approved Make	L&T / Siemens / Schneider / GE Power Control / Jean Muller /Busmann / ABB
	26	CT's for 1250A Incoming Feeder	7 Nos. Single resin cast. a) 3 no's dual core CT's of ratio 1250/5A <ul style="list-style-type: none"> • Core 1: Class 0.5 & 15VA burden – For MFM • Core 2: 5P20 & 15VA – For Ashida make O/C+E/F relay b) 3 no's single core CTs of ratio 1250/5 A, Class 0.5 & 15 VA for Energy meter (Energy meter is not in bidder scope) c) 1 no single core CT of ratio 1250/5A, 5P20 & 15 VA for Neutral unbalance protection Approved Make of CTs: Reco/Newtek/Pragati/Kappa/ECS/Adcon
	27	TTB for Metering	Front connection, Screw Type 3 Phase 4 Wire, 4SF, 50 A, DAV/IMP make
	28	Wiring convention for TTB	Incoming from Bottom Side & Outgoing to Meter from Top side
	29	Multifunction Digital meter	Should be communicable on Modbus RS 485
	30	Earth Fault protection relay (NEF)	Alstom make CDG11 self-powered. Relay type is normal inverse with 3 Sec with E/F setting of 0.5 to 2 A
	31	Earthing Hardware	a) Earthing Nut and Bolt shall be M12 SS b) Washers shall be with Hot Dip Galvanized with 80 micron Galvanisation or Alu-Zinc coating.
	31a	Panel Earthing	Earthing provision to be provided on both sides with 50 mm extension of main Earth Bus Bar.
	32	Clearance between live parts	Phase - phase -Minimum 25 mm & Phase - earth - Minimum 20 mm
33	Distance between each fuse outlet	Centre to Centre - 150mm (Minimum)	

Rev No.	Prepared By & Date	Checked By & Date	Approved for Issue By & Date
R00	Yash M. Mane 	Ajay V. Potdar 	Ravindra M. Bhanage 
	11/01/2024	11/01/2024	11/01/2024

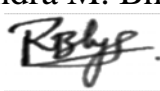

34	Distance between fuse outlet & panel surface	125 mm (Minimum)
35	Control terminals for CTs	Stud type with disconnecting facilities
36	Control terminals for Voltage & other circuits	Stud type
37	Illumination and Indicating Bulb	LED
38	Continuous rated operating voltage	440 volt +/- 10%
39	High voltage withstand capacity	2000 volt at 50 Hz for 1minute
40	Insulation resistance ph-ph & ph-earth	Minimum 10M Ω with 500V Megger
41	Labels & name plates	As per Specifications
42	Surface preparation for painting	Sand blasting or 7 tank process
43	Painting	Sand blasting or 7 tank process. Light grey shade No 631 of IS-5 Powder coated epoxy paint min thickness 120 micron
44	Power Supply Socket	5A/15A Plug point socket to be provided
45	Breaker Barrier	Breaker must have a metallic removable sheet from the front side which will act as a barrier between operator and the breaker. Provision must be given for breaker operation to be done through this barrier.
46	Branding Plate	All supplied Units shall be fitted with engraved metallic logo of Tata Power on the front side. The Tata Power Co Ltd to be mentioned below the logo with clear font and Dimension 12*12 Inches. * Refer Annexure 2
47	Panel Dimensions (Min depth of 900 mm)	L X D X H
48	Numerical Relay	Ashida (ADR 241S) with 4 Element
49	Bus-bar phase barriers/ Phase separators (R-Y & Y-B)	FRP insulating sheet - (to be placed near to the phase bus-bar) (min 3 mm thickness) shall be provided between bus-bars, so as to ensure that there is no accidental contact with any live parts. (65 mm width)

Rev No.	Prepared By & Date	Checked By & Date	Approved for Issue By & Date
R00	Yash M. Mane 	Ajay V. Potdar 	Ravindra M. Bhanage 
	11/01/2024	11/01/2024	11/01/2024



5.0

**GENERAL
CONSTRUCTION**

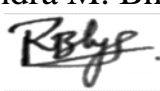
- 1) The feeder pillar frame shall be fabricated using suitable mild steel structural section or pressed and shaped Cold Rolled Closed Annealed (CRCA) sheet of thickness 3 mm.
- 2) Frames shall be enclosed by CRCA sheet of thickness 3mm, smoothly finished, levelled and free from flaws. Doors and cover shall be made of CRCA sheet of thickness not less than 2.5mm. Stiffeners shall be provided, wherever necessary. Gland plates shall be of Hot Rolled Closed Annealed (HRCA) thickness not less than 3 mm. alternatively gland can also be provided between two angles so that removal of gland is easy. The dimension of base frame should be 75mm X 40mm X 5 mm.
- 3) The panel shall be of metal enclosed and outdoor type, support frame mounted type with canopy of adequate slope to avoid water accumulation. Degree of protection shall be IP 54.
- 4) Breaker compartment and fuse compartment should be separated by metallic sheet; the same should be split suitably in order to avoid local heating due to eddy currents generated by three phase bus bars crossing through the same sheet. The breaker compartment should be in center of panel & Outgoings shall be on both the sides of breaker compartment.
- 5) The panel shall be of dust and vermin proof construction and of self-cooled design with adequate louvers on sides and top portion. The louvers shall have fine wire mesh made of brass. The minimum depth of panel shall be 900 mm.
- 6) Labels on the front and rear indicating the panel designation, phase marking and danger signs shall be provided. Single Line Diagram & feeder details shall be engraved and pasted on inside of panel.
- 7) Danger boards shall be provided in local languages on the Hylam sheet below breaker and on front & rear cover with red background and with white letters.
- 8) Hinged doors of lift off type, with concealed type with brass type hinges and captive screws shall be provided on the front side & Back side. Adequate numbers of door hinges shall be provided and should be durable and easy in operation. All doors shall be provided with padlocking facility. The design of doors should permit inter-changeability. The back-side doors shall have nut and bolt arrangement. All Hinged doors shall be connected to the earth terminal with 2.5 Sq.mm braided copper wires.
- 9) Cable entry facilities at bottom of panel and removable gland plates of size suitable to accommodate incoming & outgoing cables of sizes, 4 Core 300 Sq mm 1.1 KV XLPE Cable, shall be provided at required locations.
- 10) Distance between Gland plate and cable termination of Air Circuit Breaker should be minimum 600mm.
- 11) The panel shall be provided with gasket all around the perimeter of covers, gland plates, removable covers and doors.
- 12) ACB termination shall be with tinned copper or tinned aluminium Bus Bar. Wherever required bimetallic washer to be provide, if bare copper terminal is provided.

Rev No.	Prepared By & Date	Checked By & Date	Approved for Issue By & Date
R00	Yash M. Mane 	Ajay V. Potdar 	Ravindra M. Bhanage 
	11/01/2024	11/01/2024	11/01/2024

- 13) Busbars shall be of aluminium with Bakelite shrouding, rated for 1250 A, 50 kA for 1 sec and shall have adequate cross section to carry the rated continuous and short time current. Main Bus bar should be continuous/ without any joint. All bus bars, bus taps and joints shall be PVC taped. Neutral bus bar shall be provided on read side & rated for full bus bar rating.
- 14) The ACBs shall be mechanical operated fixed type 3 Pole with shunt trip coil without any microprocessor protection release. Ashida make (ADR41S) relay to be provided for tripping the breaker with Overcurrent & earth fault protection. Spare ACB contacts for shunt trip should be provided.**
- 15) All fuses shall be of the HRC cartridge type mounted on plug-in type fuse bases having a prospective current of not less than 80 kA.
- 16) Phase to phase clearance of 25mm and Phase to Neutral / Earth clearance of 20mm shall be provided in the panel.
- 17) Distance between centre to centre should be minimum 150 mm between each fuse outlet and 125 mm between fuse outlet and body of panel to be maintained.
- 18) The panel shall be provided with two separate earthing terminals connected to earth bus.
- 19) All instruments shall be connected to the earth terminal using 650V grade PVC insulated 2.5 sq mm stranded tinned copper earthing conductor. All Earthing should be routed properly along with body of panel.
- 20) All hinged doors, Covers, Gland Plates shall be connected to the earth terminal, with the help of braided copper conductors of adequate size. Flat earth bus should be protruded out for connection of external earth
- 21) Eyebolt of suitable sizes shall be provided for lifting arrangements.
- 22) All wiring shall be carried out with 650V grade PVC insulated stranded copper conductors of adequate sizes to suit the rated circuit current.
- 23) The panel shall be powder coated with light shade grade no 631 of IS 5.
- 24) Required number of foundation bolts shall be supplied with the panel.
- 25) Control fuses with control terminals for external cable connections shall be in the breaker chamber only.
- 26) The control terminals shall be as follows:
- Stud type with disconnecting facilities for CT circuits
 - Stud type for voltage and other circuits.
- 27) Fuse bases shall have adequate contact surface with the bus bars provided to ensure that no local heating takes place.
- 28) Lighting System in Feeder Pillar should be LED based.

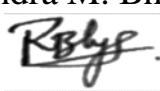
Rev No.	Prepared By & Date	Checked By & Date	Approved for Issue By & Date
R00	Yash M. Mane 	Ajay V. Potdar 	Ravindra M. Bhanage 
	11/01/2024	11/01/2024	11/01/2024

6 Way LT Panel: Representative GA drawing & SLD-

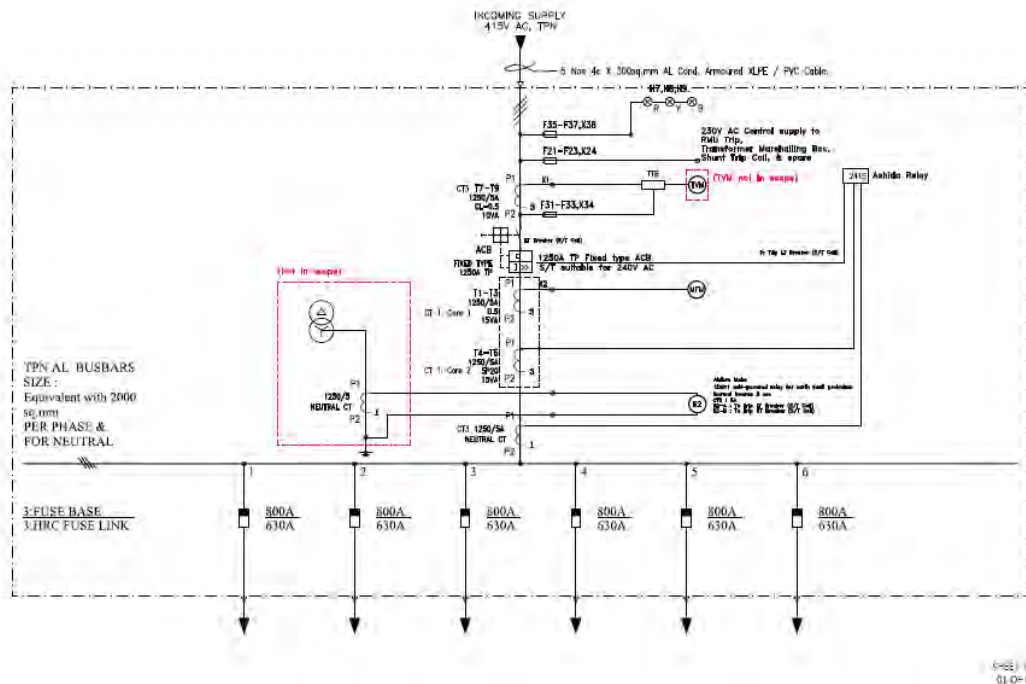
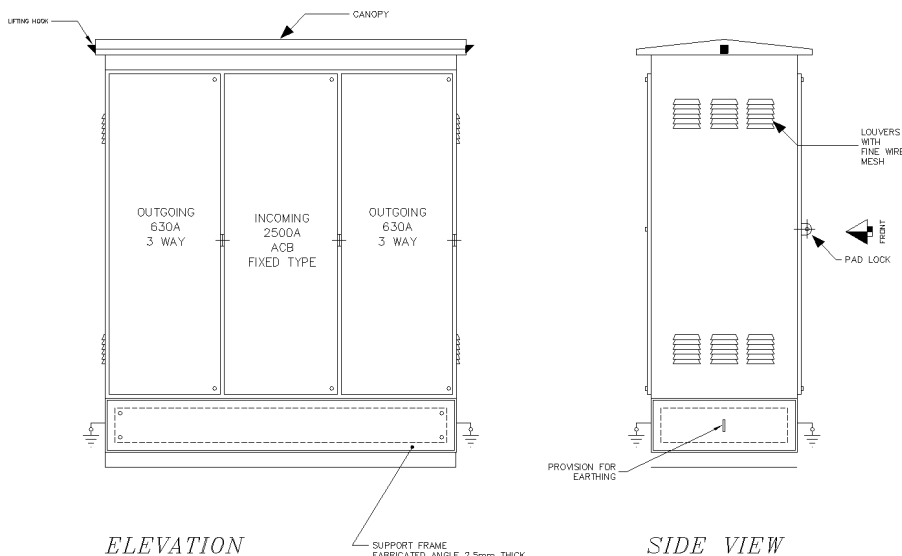

5-021 10/ 01-01-01

Rev No.	Prepared By & Date	Checked By & Date	Approved for Issue By & Date
R00	Yash M. Mane 	Ajay V. Potdar 	Ravindra M. Bhanage
	11/01/2024	11/01/2024	11/01/2024

Control Wiring Diagram:

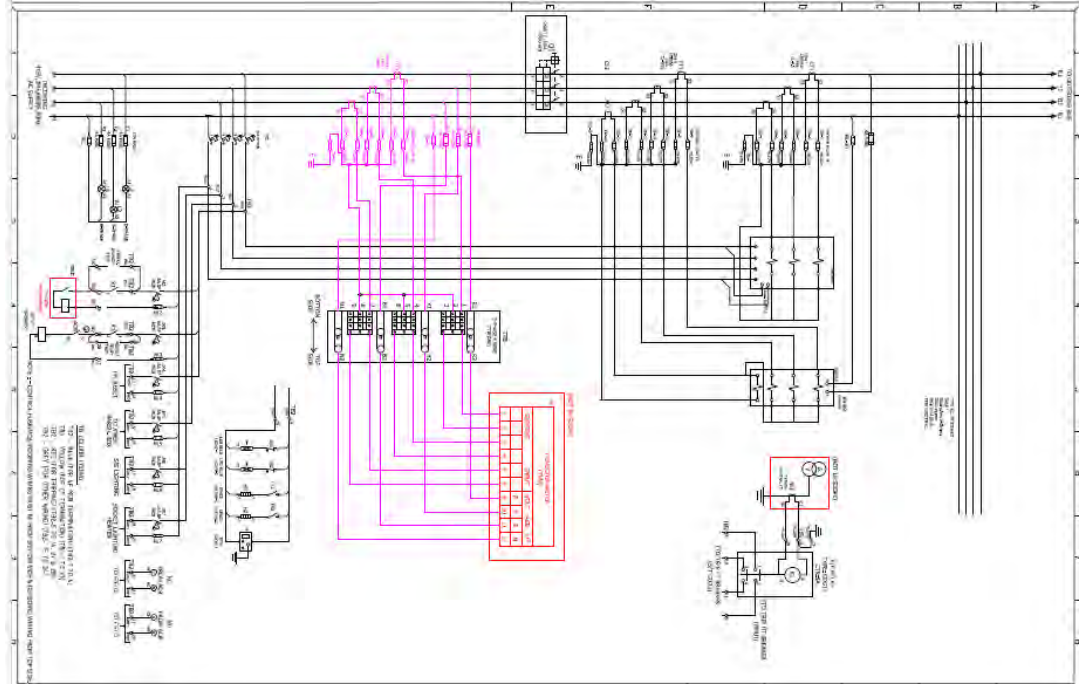

5.1

Specific Requirements

- a) The LT Panel should be 6 way type having 6 Nos. outlets per phase respectively as per tender requirement.
- b) Material Quality Plan, general arrangement drawing and single line diagram of the feeder pillar to be approved before manufacturing.
- c) Adequate cable termination shall be provided as follows

Sr. No.	TYPE	UoM	No. of Cable	Description
1	1250A Incomers	1No.	6	1.1KV, 4C, 300 sqmm AL cond. Armoured XLPE/PVC Cable
2	6 Way Panel 630 A Fuse Outgoing	6 No. Per outgoing	2	1.1KV, 4C, 300 sqmm AL cond. Armoured XLPE/PVC Cable

- d) 1250A Incomer shall be provided with resin cast CTs of ratio 1250/5A for metering & protection.
- 3 no's dual core CT 1250A/5A, Core 1: 0.5 CI, Core 2: 5P20, 15 VA, to be used for MFM.

Rev No.	Prepared By & Date	Checked By & Date	Approved for Issue By & Date
R00	Yash M. Mane 	Ajay V. Potdar 	Ravindra M. Bhanage
	11/01/2024	11/01/2024	11/01/2024



3 no's single core CT 1250A/5A, 0.5, 15 VA, to be used for Energy metering.

1 no single core CT 1250A/5A, 5P20, 15 VA, to be used for neutral unbalance protection.

- e) All CT termination should be round plug type. No CT shorting arrangement to be provided. (As per SLD)
- f) Secondary wiring shall be carried out with 1.1KV grade PVC insulated stranded copper conductor of 2.5 Sq. mm for CT circuits and 2.5 Sq. mm for PT and other circuits. All wires will be colour coded.

Sr. No.	Equipment	Colour	Nomenclature of TBs	Types of TBs
1.	TBs of 4 Pole MCB Termination	Blue	TB2	Droppable
2.	TBs for CT Termination	Yellow	TB1	Droppable
3.	TBs for Tripping	Red	TB2	Droppable
4.	All others	Default	TB2	Normal

- g) The feeder pillar panel shall be provided with Alstom Make CDG11 self-powered relay for earth fault protection. The relay type is normal inverse with 3 sec with E/F setting of 0.5 to 2 A.
- h) Test terminal box for Energy Metering should be Front Connection, Screw Type (4SF), 50 A to be provided and the convention of the wiring in the TTB should be Incoming from the bottom side and outgoing to Meter from top side. There must not be any partition between Relay & metering box in LV compartment. It should be single door compartment. No lugs shall be provided for wires to meter, TTB, and Fuses (PT secondary). Sealing arrangement to be provided for Energy Meters. Inspection glass (Transparent Toughened Glass) to be provided for viewing of meter.
- i) All Protection/ control wiring must terminate in LV compartment.
- j) Provision to be provided for mounting the energy meter with max dimensions as L x B x D: 360 x 200 x 200 mm (Energy meter will be supplied by TPC). The relay and energy meter shall be installed in the breaker compartment with suitable partitions. The relays shall be supplied by the vendor.
- k) The LT panel shall be equipped with shrouded type anti condensation space heaters with thermostat, internal light with switch & 5A/15A metal clad general-purpose plug socket.

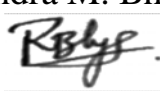
Rev No.	Prepared By & Date	Checked By & Date	Approved for Issue By & Date
R00	Yash M. Mane 	Ajay V. Potdar 	Ravindra M. Bhanage 
	11/01/2024	11/01/2024	11/01/2024

- l) The following separate control circuit 20A, 4 pole MCB duly wired up to terminal block for purchaser's use shall be provided before the circuit breaker in feeder pillars leading to following single pole MCB with neutral links (refer SLD):

Phase and neutral for 230V supply to RMU. (6A)

Phase and neutral for 230V supply to Transformer marshalling box. (6A)

Phase and neutral for external shunt trip coil (6A)

Phase and neutral for FPI reset (6A)

Separate 16A, DP MCB duly wired for Auxiliary supply for LT panel for following purpose,

Phase and neutral for substation lighting (6A)

Phase and neutral for Socket (15A)/ Heater circuit

Phase and neutral for Ashida overcurrent relay (4A)

- m) The following separate control fuses with neutral links duly wired out to a set of stud type link terminals for purchaser's use shall be provided before the circuit breaker in feeder pillars Control fuse Incoming wiring must be from bottom side & Outgoing wiring from top side. (refer SLD):

Three phase and neutral for metering circuit.

Three Phase and neutral for indication lamp

- n) Locking should be of welded type. Earthing jumpers to be provided for all the doors. Louvers with stainless steel wire mesh to be provided on body side and cover plate.

- o) Makes of various bought out items shall be limited to the following:

Sr. No.	Items	Approved Make
1	ACB	Schneider/ L&T/ Siemens/ C&S/ ABB/ Eaton
2.	CT	Reco/Newtek/Pragati/Kappa/ECS/Adcon

- p) Flexible copper braiding should be provided on the doors. Neutral bus shall be connected with earth bus. All control cable should be multi stranded and FRLS. CT ISF should be less than or equal to 5. Close and Open status of the breaker should be available on SCADA through spare auxiliary contact and on LT panel through LED Lamp.



- q) The fuses provide should be of knife type and same should be removable with the help of fuse puller. There shall be no obstruction during removal of outgoing fuses by fuse puller.

- r) The safety locking facility to be provided for putting three nos. of safety locks.

- s) Panel minimum width in mm: 900 mm

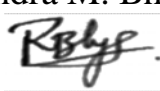

- t) The breaker manufacturer to provide the complete support in terms of training; hand holding to our Testing and O&M staff. The breaker manufacturer to give the support service for next 10 years.

- u) The robust isolating arrangement in the OG fuse compartment to be made as per the

Rev No.	Prepared By & Date	Checked By & Date	Approved for Issue By & Date
R00	Yash M. Mane 	Ajay V. Potdar 	Ravindra M. Bhanage 
	11/01/2024	11/01/2024	11/01/2024

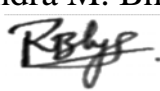

The Tata Power Company Limited		TECHNICAL SPECIFICATION OF 6 Way 1250 A LT Panel
ENSE-DS-2031-R00		Date of Issue: 11/01/2024

6.0	NAME PLATE AND MARKING	<p>6.1 Name plate- On front door top left side-showing</p> <ol style="list-style-type: none"> 1) Purchaser name & PO number. 2) Manufacturer name 3) Month / year of manufacturing 4) 'Property of Tata Power' <p>6.2 Marking for panel earth stud- Black letter 'E', on riveted AI label</p> <p>6.3 Danger board in English & local language, riveted on doors- White colour background with red lettering on 1.6mm thick AI plate.</p> <p>6.4 SLD shall be engraved & pasted on inside of door.</p> <p>6.5 CT Serial Nos., Ratio & ACB Serial Nos. to be written on doors with marker pen.</p> <p>6.6 Separate metallic name plate with Tata Power Logo of Dimension 12*12 Inches in clear font as shown in Annexure-2.</p>
7.0	TESTS	<p>All routine, acceptance & type tests shall be carried out in accordance with the relevant IS/IEC. Following tests shall be necessarily conducted on the 'Feeder Pillar' in addition to others specified in IS/IEC standards.</p> <p>*In case of any conflict on any technical particular, the stricter requirement mentioned in the relevant standard shall be valid.</p>
7.1	Type test	<p>Type test - Only type tested components – ACBs, Fuses, Insulators & aluminium bus bar shall be accepted. Following type test shall be carried out on the assembly.</p> <ol style="list-style-type: none"> a) Verification of temperature-rise limits – Clause 8.2.1 of IS 8623 b) Verification of dielectric properties – Clause 8.2.2 of IS 8623 c) Verification of short-circuits strength – Clause 8.2.3 of IS 8623 d) Verification of continuity of the protective circuit – Clause 8.2.4 of IS 8623 e) Verification of clearance and creepage distances – Clause 8.2.5 of IS 8623 f) Verification of mechanical operation – Clause 8.2.6 of IS 8623 f) Verification of degree of protection – Clause 8.2.7 of IS 8623
7.2	Routine test	<p>Acceptance & routine test- (Inspection test witness by purchaser as per approved Quality Assurance Plan)</p> <ol style="list-style-type: none"> 1) Visual inspection, dimension checks & paint thickness checks. 2) Bill of material check 3) Insulation resistance test 4) High voltage test 5) Operational check 6) Verification of dielectric properties 7) Tolerances on panel dimensions- Maximum +/- 5mm 8) No negative tolerance on bus bar dimensions & bus bar clearances 9) Stability test shall be conducted on all Panels, to ensure there shall be no tripping in case of unbalance current on earth fault function.

Rev No.	Prepared By & Date	Checked By & Date	Approved for Issue By & Date
R00	Yash M. Mane 	Ajay V. Potdar 	Ravindra M. Bhanage 
	11/01/2024	11/01/2024	11/01/2024

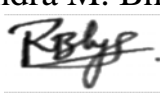

The Tata Power Company Limited		TECHNICAL SPECIFICATION OF 6 Way 1250 A LT Panel
ENSE-DS-2031-R00		Date of Issue: 11/01/2024

7.3	Acceptance test	<ol style="list-style-type: none"> 1) Visual inspection & dimensional check 2) Verification of clearance and creepage distance 3) Paint thickness check 4) Wiring checks 5) Insulation resistance test 6) HV test 7) Stability test on all Panels, to ensure there shall be no tripping in case of unbalance current on earth fault function. 8) 1 unit from 1st lot shall be tested for Temperature rise test with ACB and fuses. (Bidder to arrange for the same, either in factory or in external lab)
8.0	TYPE TEST CERTIFICATE	<p>The Bidder shall furnish the type test certificates for the tests as mentioned above as per the corresponding standards. Type Test to be conducted on similar Design/ rating panel. All the tests shall be conducted at CPRI / ERDA/ NABL as per the relevant standards. Type test should have been conducted in certified Test Laboratories during the period not exceeding 10 years from the date of opening the bid.</p> <p>Type tests shall have been conducted in certified Test laboratories during the period not exceeding 10 years from the date of opening the bid. In case if type test conducted beyond 10 years then bidder to certify on letter head of parent OEM that no design change & no manufacturing plant change occurred from type tested product.</p> <p>In the event of any discrepancy in the test reports, i.e. any test report not acceptable or any/all type tests (including additional type tests, if any) not carried out, same shall be carried out without any cost implication to TATA POWER.</p>
9.0	PRE-DISPATCH INSPECTION	<p>The Material shall be subject to inspection by a duly authorized representative of the TATA POWER COMPANY. Inspection may be made at any stage of manufacture at the discretion of the Purchaser and the equipment, if found unsatisfactory as to workmanship or material, the same is liable to rejection. Bidder shall always grant free access to the places of manufacture to TATA POWER COMPANY `s representatives when the work is in progress. Inspection by the TATA POWER COMPANY or its authorized representatives shall not relieve the Bidder of his obligation of furnishing equipment in accordance with the specifications. TATA POWER COMPANY authorized representatives shall have the right to inspect the design, materials and workmanship and to report thereon, at any stage of manufacture, if found necessary. All facilities shall be extended to our representatives for witnessing the tests. Due notice shall be given to us to enable us to depute our representatives for stage inspection.</p> <p>Material shall be dispatched after specific MDCC (Material Dispatch Clearance Certificate) is issued by TATA POWER COMPANY.</p> <p>Five certified copies of all test certificates including type tests, sample test certificates shall be sent to us for our approval prior to dispatch of materials.</p> <p>Following documents shall be sent along with material</p> <ol style="list-style-type: none"> a) Test reports b) MDCC issued by TATA POWER COMPANY c) Invoice in duplicate d) Packing list e) Drawings & catalogue f) Delivery Challan g) Other Documents (as applicable).



Rev No.	Prepared By & Date	Checked By & Date	Approved for Issue By & Date
R00	Yash M. Mane 	Ajay V. Potdar 	Ravindra M. Bhanage 
	11/01/2024	11/01/2024	11/01/2024

The Tata Power Company Limited		TECHNICAL SPECIFICATION OF 6 Way 1250 A LT Panel
ENSE-DS-2031-R00		Date of Issue: 11/01/2024

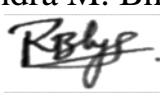
10.0	INSPECTION AFTER RECEIPT AT STORE	<p>The material received at TPC, Mumbai store shall be inspected for acceptance and shall be liable for rejection, if found different from the reports of the pre-dispatch inspection or any other parameters observed after delivery.</p> <p>The material should be delivered at TPC, Mumbai stores within 45 days from the date of manufacturing, same shall be checked during delivery and overdue material shall not be accepted. Bidders to plan the delivery accordingly.</p> <p>Bidders to attend and rectify the same at his own cost. The material shall be accepted in stores only after rectification of any observed flaw. The delay in rectification shall lead to any contractual penalty.</p> <p>Billing shall be processed only after acceptance of the material.</p>
11.0	GUARANTEE	<p>Bidder shall stand guarantee towards design, materials, workmanship & quality of process / manufacturing of items under this contract for due and intended performance of the same, as an integrated product delivered under this contract.</p> <p>In the event any defect is found by the TATA POWER COMPANY up to a period of at least 12 months from the date of commissioning or 24 months from the date of last supplies made under the contract whichever is later, (the time scale of 12/24 months could be enhanced subject to mutual agreements) Bidder shall be liable to undertake to replace/rectify such defects at its own costs, within mutually agreed time frame, and to the entire satisfaction of the Purchaser, failing which the TATA POWER COMPANY will be at liberty to get it replaced/rectified at Bidder's risks and costs and recover all such expenses plus the Purchaser's own charges (@ 20% of expenses incurred), from the Bidder or from the " Security cum Performance Deposit" as the case may be.</p> <p>In case of GP failure, BA shall report at site within 48 hours from intimation and arrange for rectification of fault within a mutually agreed time. In case rectification at site is not possible then alternative arrangement (replacement) to be made by BA within 15 days of intimation of failure.</p> <p>Bidder shall further be responsible for 'free replacement' for another period of THREE years from the end of the guarantee period for any 'Latent Defects' if noticed and reported by the Purchaser.</p>
12.0	PACKING AND TRANSPORT	<p>Bidder shall ensure that the item covered under this specification shall be packaged for rail/road transport in a manner so as to protect the equipment from damage in transit.</p> <ol style="list-style-type: none"> 1) Packing protection- Against shocks, vibration & corrosion, damages during transportation 2) Packing identification labels, to show purchaser name, PO number, quantity of panels, Panel type, Manufacturer serial number 3) Handling instruction- To be marked on packing boxes. 4) Bidders should prefer to use recyclable & environmentally friendly materials for packing. 5) No single use plastic to be used. 6) Packing should be done with environment friendly recyclable materials.
13.0	TENDER SAMPLE	Not Applicable

Rev No.	Prepared By & Date	Checked By & Date	Approved for Issue By & Date
R00	Yash M. Mane 	Ajay V. Potdar 	Ravindra M. Bhanage 
	11/01/2024	11/01/2024	11/01/2024

14.0	QUALITY CONTROL	<p>The Bidder shall submit with the offer Quality assurance plan indicating the various stages of inspection, the tests and checks which will be carried out on the material of construction, components during manufacture and bought out items and fully assembled component and equipment after finishing. As part of the plan, a schedule for stage and final inspection within the parameters of the delivery schedule shall be furnished.</p> <p>TATA POWER COMPANY shall reserve the sole rights for the type test of a random sample from the lot and in case of any discrepancy or deviation from the Type test certificates submitted along with the Bid; the complete Lot shall be rejected.</p> <p>TATA POWER COMPANY representative or its nominated representative shall have free access to the Bidder's works to carry out inspections.</p> <p>If anything missing in QAP and required as per other clauses of this document, bidder is liable to perform the same without cost implication.</p>
15.0	MINIMUM TESTING FACILITIES	Bidder shall have adequate in-house testing facilities for carrying out all routine tests & acceptance tests as per relevant International / Indian standards and as specified above.
16.0	MANUFACTURING ACTIVITIES	The successful bidder will have to submit first GTP & Drawing with 7 days from placement of outline agreement for approval and complete the approval process within 14 days of outline agreement. The date of Code -2/ Code-1 approval given by TATA Power will be treated as first day for assessment of LD (if applicable).
17.0	SPARES, ACCESSORIES, AND TOOLS	Keys of door
18.0	DRAWING AND DOCUMENTS	<p>Following drawings and documents shall be prepared based on TATA POWER COMPANY specifications and statutory requirements and shall be submitted with the bid.</p> <p>All the documents & drawings shall be in English language</p> <ul style="list-style-type: none"> a) Completely filled in Technical Particulars b) General description of the equipment and all components including brochures. c) General arrangement drawing. d) Bill of material e) Experience List f) Type test certificates
19.0	SCHEDULE "A" GUARANTEED TECHNICAL PARTICULARS	Bidders to comply for all above requirement of specifications clauses & submit signed and stamp copy as technical compliance document.

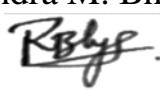
Rev No.	Prepared By & Date	Checked By & Date	Approved for Issue By & Date
R00	Yash M. Mane  11/01/2024	Ajay V. Potdar  11/01/2024	Ravindra M. Bhanage  11/01/2024

20.0

**SCHEDULE
"B" DEVIATIONS**

The bidders shall set out all deviations from this specification, Clause by Clause in this schedule. Unless specifically mentioned in this schedule, the tender shall be deemed to confirm the purchaser's specifications.

(TO BE ENCLOSED WITH THE BID)

All deviations from this specification shall be set out by the bidders, clause by Clause in this schedule. Unless specifically mentioned in this Schedule, the tender shall be deemed to confirm the purchaser's specifications:



Sr.No.	Clause No.	Details of deviation with justifications

We confirm that there are no deviations apart from those detailed above.

Seal of the Company

Signature :

Designation :

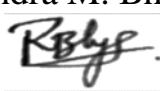
Rev No.	Prepared By & Date	Checked By & Date	Approved for Issue By & Date
R00	Yash M. Mane 	Ajay V. Potdar 	Ravindra M. Bhanage 
	11/01/2024	11/01/2024	11/01/2024



The Tata Power Company Limited		TECHNICAL SPECIFICATION OF 6 Way 1250 A LT Panel
ENSE-DS-2031-R00		Date of Issue: 11/01/2024

Annexure – 1

Inspection Testing Plan

1. Visual inspection & dimensional check
2. Verification of clearance and creepage distance
3. Paint thickness check
4. Wiring checks
5. Insulation resistance test
6. HV test
7. Stability test on all Panels, to ensure there shall be no tripping in case of unbalance current on earth fault function
8. 1 unit from 1st lot shall be tested for Temperature rise test with ACB and fuses. (Bidder to arrange for the same, either in factory or in external lab)

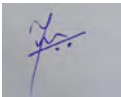
TATA POWER

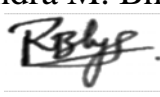
Rev No.	Prepared By & Date	Checked By & Date	Approved for Issue By & Date
R00	Yash M. Mane 	Ajay V. Potdar 	Ravindra M. Bhanage 
	11/01/2024	11/01/2024	11/01/2024

Annexure – 2

Tata power Branding Name plate -

Separate metallic name plate with Tata Power Logo of Dimension 12*12 Inches in clear font as shown below.

Relationship between the two marks- size

The Tata and Tata Power Marks are always used in conjunction with each other, never appearing in isolation on Tata Power communication.

The height of the letter T of Tata (T-height) is the basic measure for all sizes and proportions.

The rounded measure 2T in height, is separated from the Tata lettering by a distance of 1/2T.

The T height of both, the Tata and the Tata Power Marks is to be the same, except in exceptional cases on approval from the Corporate Communications team.





Relationship between the two marks- positioning

The two marks can appear stacked, which is the preferred placement, or linear, by the side of one another.

Centre aligned - Stacked (Preferred)



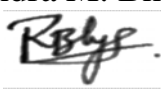

Rev No.	Prepared By & Date	Checked By & Date	Approved for Issue By & Date
R00	Yash M. Mane 	Ajay V. Potdar 	Ravindra M. Bhanage 
	11/01/2024	11/01/2024	11/01/2024

The Tata Power Company Limited		TECHNICAL SPECIFICATION OF 6 Way 1250 A LT Panel
ENSE-DS-2031-R00		Date of Issue: 11/01/2024

Annexure – 3

Reference drawings

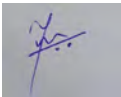
TATA POWER

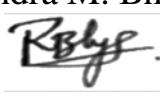
Rev No.	Prepared By & Date	Checked By & Date	Approved for Issue By & Date
R00	Yash M. Mane 	Ajay V. Potdar 	Ravindra M. Bhanage 
	11/01/2024	11/01/2024	11/01/2024

TO OUTGOING BUS
R1 Y1 B1 N1

TPN AL BUSBARS
SIZE :
Equivalent with area
2000 sq.mm
PER PHASE &
FOR NEUTRAL

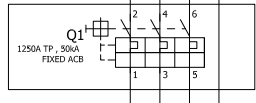
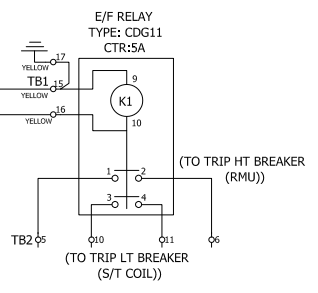
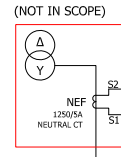
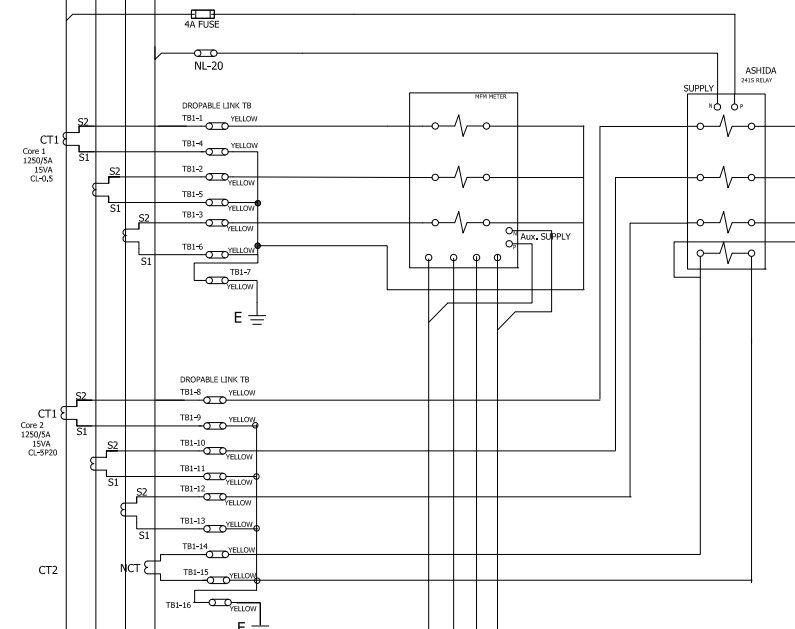

(NOT IN SCOPE)

TRIVECTOR METER (TVM)															
CURRENT				INPUT				VOLT				ACB		L/P	
1	2	3	4	5	8	9	10	R	Y	B	N	11	12		

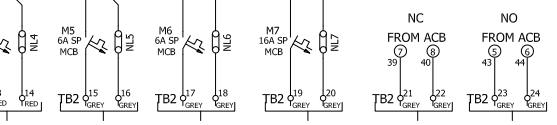
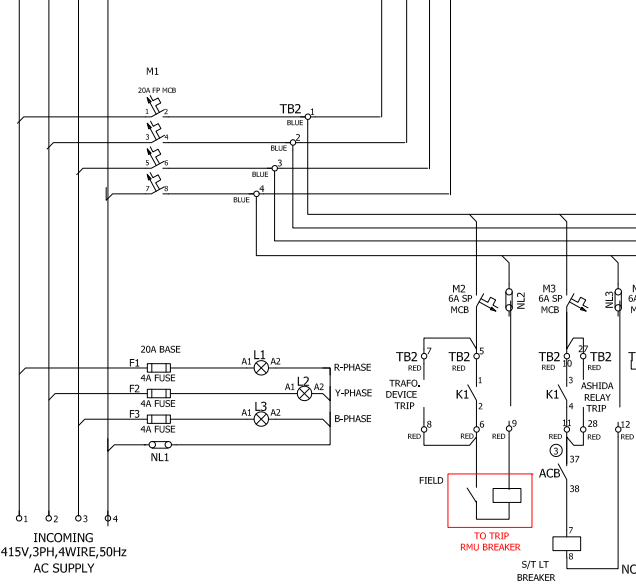
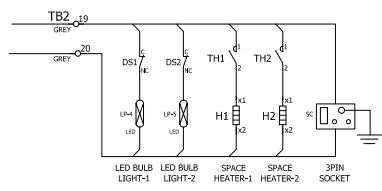
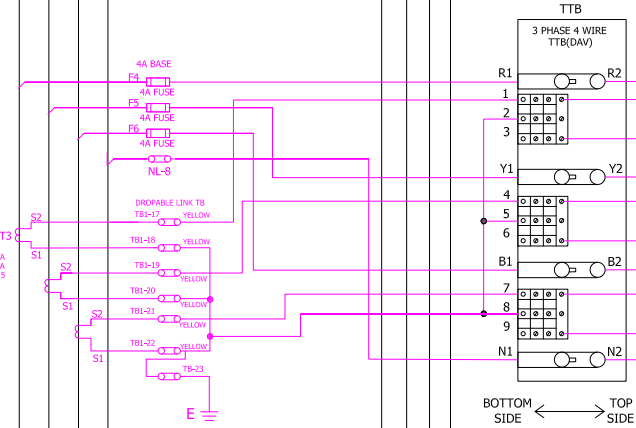

TO TRIP RMU BREAKER
S/T LT BREAKER

NOTE :- CONTROL FUSE/MCB INCOMING WIRING MUST BE FROM BOTTOM SIDE & OUTGOING WIRING FROM TOP SIDE.

TB COLOUR CODING :-
TB2 :- BLUE (FOR 4P MCB TERMINATION) [TB2-1 TO 4]
TB1 :- YELLOW (FOR CT TERMINATION) [TB1-1 TO 23]
TB2 :- RED (FOR TRIPPING) [TB2-5 TO 14, 27 & 28]
TB2 :- GREY (FOR OTHER WIRING) [TB2- 15 TO 24]

INCOMING SUPPLY
415V AC, TPN

5 Nos 4c X 300sq.mm AL Cond. Armoured XLPE / PVC Cable.

H7,H8,H9.

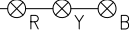

F35-F37,X38

F21-F23,X24

230V AC Control supply to
RMU Trip,
Transformer Marshalling Box,
Shunt Trip Coil, & spare

CT3 T7-T9
1250/5A
CL-0.5
10VA

P1

P2

X1

3 F31-F33,X34

TTB



(TVM not in scope)

241S

Ashida Relay

LT Breaker (S/T Coil)

ACB

FIXED TYPE
1250A TP

P1

P2

X2

3



To Trip LT Breaker (S/T Coil)

(Not in scope)

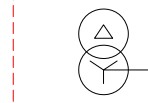

T1-T3
1250/5A
0.5
15VA

T4-T6
1250/5A
5P20
15VA

CT 1: Core 1

CT 1: Core 2

P1

P2

3

3

Alatom Make
CDG11 self-powered relay for earth fault protection
Normal Inverse 3 sec
CTR : 5A
R2-A : To Trip LT Breaker (S/T Coil)
R2-B : To Trip HT Breaker (S/T Coil)



CT3 1250/5A
NEUTRAL CT

P1

P2

1

1

1250/5
NEUTRAL CT

P1

P2

1

1

TPN AL. BUSBARS
SIZE :
Equivalent with 2000
sq.mm
PER PHASE &
FOR NEUTRAL

3:FUSE BASE
3:HRC FUSE LINK

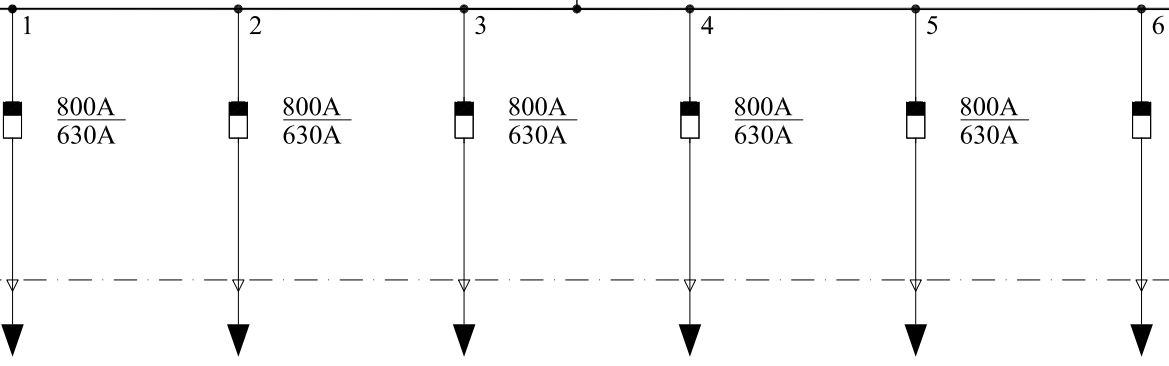

TECHNICAL SPECIFICATION

6 Way 2000 A LT Panel



The Tata Power Company Ltd.
Engineering Services (ENSE),
Distribution Division,
Senapati Bapat Marg,
Lower Parel,
Mumbai – 400013
Maharashtra



The Tata Power Company Limited		TECHNICAL SPECIFICATION OF 6 Way 2000 A LT Panel
ENSE-DS-2032-R00		Date of Issue: 11/01/2024

TECHNICAL SPECIFICATION COVER SHEET

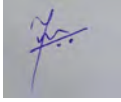
Document No: ENSE-DS-2032-R00

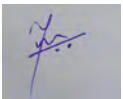

Document Title: Technical SPECIFICATION OF 6 Way 2000 A LT Panels

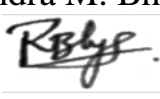
R00	ENSE-DS-2032-R00 (For Tendering Purpose)	11/01/2024	YMM		AVP		RMB	
R2	SPEC-NET-Feeder Pillar-2000A	14/7/17	ND	-sd-	SBK	-sd-	CKC	-sd-
R1	SPEC-NET-Feeder Pillar-2000A	13/10/16	ND	-sd-	SBK	-sd-	CKC	-sd-
R0	SPEC-NET-Feeder Pillar-2000A	10/06/16	AP	-sd-	SBK	-sd-	CKC	-sd-
Rev No.	Remarks	Date	Initials	Sign	Initials	Sign	Initials	Sign
			Prepared By		Reviewed By		Approved & Issued By	

Rev No.	Prepared By & Date	Checked By & Date	Approved for Issue By & Date
R00	Yash M. Mane 	Ajay V. Potdar 	Ravindra M. Bhanage 
	11/01/2024	11/01/2024	11/01/2024

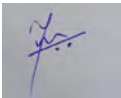

CONTENTS

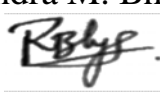
	<u>PAGE NO</u>
1.0 SCOPE	4
2.0 APPLICABLE STANDARDS	4
3.0 CLIMATIC CONDITIONS OF THE INSTALLATION	5
4.0 GENERAL TECHNICAL REQUIREMENTS	5
5.0 GENERAL CONSTRUCTIONS	9
6.0 NAME PLATE & MARKINGS	15
7.0 TESTS, ROUTINE & ACCEPTANCE TESTS	15
8.0 TYPE TEST CERIFICATES	16
9.0 PRE-DISPATCH INSPECTION	16
10.0 INSPECTION AFTER RECEIPT AT STORE	17
11.0 GUARANTEE	17
12.0 PACKING AND TRANSPORT	17
13.0 TENDER SAMPLE	17
14.0 QUALITY CONTROL	18
15.0 MINIMUM TESTING FACILITIES	18
16.0 MANUFACTURING ACTIVITIES	18
17.0 SPARES, ACCESSORIES AND TOOLS	18
18.0 DRAWING AND DOCUMENTS	18
19.0 SCHEDULE "A" GUARANTEED TECHNICAL PARTICULARS	18
20.0 SCHEDULE "B" DEVIATIONS	19
+ ANNEXURE 1, 2 & 3	

Rev No.	Prepared By & Date	Checked By & Date	Approved for Issue By & Date
R00	Yash M. Mane 	Ajay V. Potdar 	Ravindra M. Bhanage 
	11/01/2024	11/01/2024	11/01/2024

The Tata Power Company Limited		TECHNICAL SPECIFICATION OF 6 Way 2000 A LT Panel
ENSE-DS-2032-R00		Date of Issue: 11/01/2024

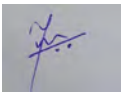
1.0	SCOPE	<p>This specification covers design, engineering, manufacture; shop testing, inspection, painting, packing, and supply of 415V, 2000 A LT Panel with 6 no Outgoing Feeders complete with all accessories for efficient and trouble-free operation of the distribution network for Tata Power Company Limited at Mumbai.</p> <p>It is not our intent to specify completely herein all details of design and construction of the equipment. However, the equipment shall conform in all respects to high standards of Engineering design and workmanship and shall be capable of performing in a manner acceptable to the purchaser (TPC) who will interpret the meaning of drawings and specification and shall be entitled to reject any work or material which in his judgement is not in full accordance therewith.</p> <p>All the bought-out items shall be of reputed make and shall be subject to approval by the PURCHASER (TPC) after award of contract.</p>																																				
2.0	APPLICABLE STANDARDS	<p>The equipment shall conform to this specification and latest revision of following codes with all amendments.</p> <table border="1" style="width: 100%; border-collapse: collapse;"> <thead> <tr> <th style="width: 5%;"></th> <th style="width: 30%;">Title</th> <th style="width: 65%;">Indian standard</th> </tr> </thead> <tbody> <tr> <td style="text-align: center;">1</td> <td>IS 8623</td> <td>Specification for low voltage switchgear</td> </tr> <tr> <td style="text-align: center;">2</td> <td>IS 12063/ IEC 60529</td> <td>Classification of degrees of protection provided by Enclosures of Electrical equipment</td> </tr> <tr> <td style="text-align: center;">3</td> <td>IS 5</td> <td>Color of ready mixed paints</td> </tr> <tr> <td style="text-align: center;">4</td> <td>IS 5082</td> <td>Wrought Aluminium & Al alloy plates & sheets for electrical application</td> </tr> <tr> <td style="text-align: center;">5</td> <td>IS 2705</td> <td>Current Transformers</td> </tr> <tr> <td style="text-align: center;">6</td> <td>IS 2551</td> <td>Danger Notice plates</td> </tr> <tr> <td style="text-align: center;">7</td> <td>IS 13703-2</td> <td>Low voltage fuses for voltage not exceeding 1000 V AC or 1500 V DC. Part 2 Fuses for use by authorized persons</td> </tr> <tr> <td style="text-align: center;">8</td> <td>IEC 255</td> <td>Protection Relays</td> </tr> <tr> <td style="text-align: center;">9</td> <td>IEC 801</td> <td>Control and monitoring</td> </tr> <tr> <td style="text-align: center;">10</td> <td>IEC 60947-2 /IS 13947-2</td> <td>Low Voltage Switchgear & control gear</td> </tr> <tr> <td style="text-align: center;">11</td> <td>IEC 60269</td> <td>Low Voltage Fuses</td> </tr> </tbody> </table> <p>In case of any conflict on any technical particular in the specification, the stricter requirement mentioned in the relevant standard shall be valid.</p>		Title	Indian standard	1	IS 8623	Specification for low voltage switchgear	2	IS 12063/ IEC 60529	Classification of degrees of protection provided by Enclosures of Electrical equipment	3	IS 5	Color of ready mixed paints	4	IS 5082	Wrought Aluminium & Al alloy plates & sheets for electrical application	5	IS 2705	Current Transformers	6	IS 2551	Danger Notice plates	7	IS 13703-2	Low voltage fuses for voltage not exceeding 1000 V AC or 1500 V DC. Part 2 Fuses for use by authorized persons	8	IEC 255	Protection Relays	9	IEC 801	Control and monitoring	10	IEC 60947-2 /IS 13947-2	Low Voltage Switchgear & control gear	11	IEC 60269	Low Voltage Fuses
	Title	Indian standard																																				
1	IS 8623	Specification for low voltage switchgear																																				
2	IS 12063/ IEC 60529	Classification of degrees of protection provided by Enclosures of Electrical equipment																																				
3	IS 5	Color of ready mixed paints																																				
4	IS 5082	Wrought Aluminium & Al alloy plates & sheets for electrical application																																				
5	IS 2705	Current Transformers																																				
6	IS 2551	Danger Notice plates																																				
7	IS 13703-2	Low voltage fuses for voltage not exceeding 1000 V AC or 1500 V DC. Part 2 Fuses for use by authorized persons																																				
8	IEC 255	Protection Relays																																				
9	IEC 801	Control and monitoring																																				
10	IEC 60947-2 /IS 13947-2	Low Voltage Switchgear & control gear																																				
11	IEC 60269	Low Voltage Fuses																																				

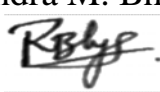
Rev No.	Prepared By & Date	Checked By & Date	Approved for Issue By & Date
R00	Yash M. Mane 	Ajay V. Potdar 	Ravindra M. Bhanage 
	11/01/2024	11/01/2024	11/01/2024

3.0

**CLIMATIC
CONDITIONS OF
THE
INSTALLATION**



1	Maximum ambient temperature	43 deg.C
2	Max. Daily average ambient temp	35 deg.C
3	Min Ambient Temperature	07 deg.C
4	Maximum Relative Humidity	100%
5	Minimum Relative Humidity	40%
6	Average No. of thunderstorm per annum	50
7	Average Annual Rainfall	2380mm
8	Average No. of rainy days per annum	115
9	Rainy months	June to Oct.
10	Altitude above MSL not exceeding	300 meters
11	Average Air Pressure	29.6-inch Hg

Atmosphere is generally laden with mild acid and dust suspended during dry months and subjected to fog in cold months. The design of the equipment and accessories shall be suitable to withstand seismic forces corresponding to an acceleration of 0.1g.

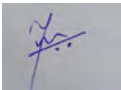

4.0

**GENERAL
TECHNICAL
REQUIREMENTS**

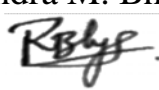

Sr. No	Item Description	Tata Power Requirement
1	Manufacturer	Name
		Manufacturer Address
		Contact telephone no
2	Breaker Rating (ACB)	2000A Manual Fixed Type without any microprocessor relay. 230V AC Shunt tripping coil to be provided.
	Model of ACB	The Model shall be such that current density in current carrying part shall be less than 3 A/sq.mm. (Bidder to mention the model)
	Approved Make	Schneider/ L&T/ Siemens/ C&S/ ABB/ Eaton
3	Main bus bar rating	2000 A
	Bus bar Size for Phase & Neutral	3000 sq.mm for Phase & Neutral
	Earth Bus	1 x 50 x 10 mm GI
4	Type of Installation	Indoor / Outdoor Type
5	No of Incoming feeders	Qty -1no. of 2000A ACB with 7 Nos of 4CX300 sq.mm Al Ar XLPE cables
6	No of outgoing feeders (6 Way)	Quantity - 6 Nos of 630A each with 2 nos of 4CX300 sq.mm Al Ar XLPE cables per O/G
7	Panel construction	CRCA sheet steel of thickness 3 mm

Rev No.	Prepared By & Date	Checked By & Date	Approved for Issue By & Date
R00	Yash M. Mane 	Ajay V. Potdar 	Ravindra M. Bhanage 
	11/01/2024	11/01/2024	11/01/2024

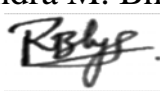

		8	Panel enclosure class	IP54 - ingress protection
		9	Sheet steel thickness	Doors & Covers - 2.5mm, FRAME - 3mm
		10	Door type for front & rear access	Double door with rear door bolted
		11	Door hinges	Minimum three anti-theft type hinges self-locking type
		12	Padlocking facility	For front door
		13	Master key for all doors	Identical for all panels, 1 no./ panel to be provided
		14	Hardware & Fasteners	All Nuts, Bolts, Washers shall be Hot Dip Galvanized with 80 micron Galvanisation or Alu-Zinc coating. Bolts below 12 mm size shall be SS material.
		14a	Current Carrying part hardware	Each bolt on Bus Bar and Fuse terminal shall be provided with Belleville washer and plain washer. Wherever required bimetallic washers to be provided
		15	Phase & neutral Bus bar	Aluminium grade 19501 (H2) as per IS 5082
			Bus bar size in mm for 2000 A O/G	3000 sq.mm for Phase & Neutral
			2000A ACB Incoming	3000 sq.mm for Phase & Neutral
			ACB O/G LINKS	3000 sq.mm for Phase & Neutral (Dimensions as per feasibility with Breaker palm connection)
		16	Bus bar color coding for R, Y, B & neutral	Heat shrinkable sleeves with color Red, Yellow, Blue & Black respectively
		16 a	Bus Bar Heat shrinkable sleeves	Cross-linked Polyolefin (Bidder to specify thickness)
		17	Main bus bar short circuit withstand capacity	Above 50kA for 1 sec
		18	Permissible maximum temperature rise above ambient of 50°C	Busbar: 45 deg C
			Permissible maximum temperature rise above ambient of 50°C	Terminals: 65 deg C
		19	Bus bar support insulators	As per IS13410 SMC / DMC, 1100V grade
		20	Incoming Cable Size	4C 300 Sq.mm Al Ar XLPE
		21	Outgoing Cable Size	4C 300 Sq.mm Al Ar XLPE

Rev No.	Prepared By & Date	Checked By & Date	Approved for Issue By & Date
R00	Yash M. Mane 	Ajay V. Potdar 	Ravindra M. Bhanage 
	11/01/2024	11/01/2024	11/01/2024

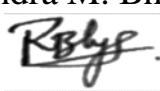
	22	Gland plate at panel bottom	HRCA MS 3mm thickness
	23	Cable termination clearance	600 mm minimum from gland plate & ACB
	24	Fuse Base	800 A
		Approved Make	L&T / Siemens / Schneider / GE Power Control / Jean Muller /Busmann / ABB
	25	Fuses (630 A)	HRC plug-in type gG (General Purpose, Fast acting fuse)
		Approved Make	L&T / Siemens / Schneider / GE Power Control / Jean Muller /Busmann / ABB
	26	CT's for 2000A Incoming Feeder	7 Nos. Single resin cast. a) 3 nos dual core CT's of ratio 2000/5A <ul style="list-style-type: none"> • Core 1: Class 0.5 & 15VA burden – For MFM • Core 2: 5P20 & 15VA – For Ashida make O/C+E/F relay b) 3 nos single core CTs of ratio 2000/5 A, Class 0.5 & 15 VA for Energy meter (Energy meter is not in bidder scope) c) 1 no single core CT of ratio 2000/5A, 5P20 & 15 VA for Neutral unbalance protection Approved Make of CTs: Reco/Newtek/Pragati/Kappa/ECS/Adcon
	27	TTB for Metering	Front connection, Screw Type 3 Phase 4 Wire, 4SF, 50 A, DAV/IMP make
	28	Wiring convention for TTB	Incoming from Bottom Side & Outgoing to Meter from Top side
	29	Multifunction Digital meter	Should be communicable on Modbus RS 485
	30	Earth Fault protection relay (NEF)	Alstom make CDG11 self-powered. Relay type is normal inverse with 3 Sec with E/F setting of 0.5 to 2 A
	31	Earthing Hardware	a) Earthing Nut and Bolt shall be M12 SS b) Washers shall be with Hot Dip Galvanized with 80 micron Galvanisation or Alu-Zinc coating.
	31a	Panel Earthing	Earthing provision to be provided on both sides with 50 mm extension of main Earth Bus Bar.
32	Clearance between live parts	Phase - phase -Minimum 25 mm & Phase - earth - Minimum 20 mm	
33	Distance between each fuse outlet	Centre to Centre - 150mm (Minimum)	

Rev No.	Prepared By & Date	Checked By & Date	Approved for Issue By & Date
R00	Yash M. Mane 	Ajay V. Potdar 	Ravindra M. Bhanage 
	11/01/2024	11/01/2024	11/01/2024

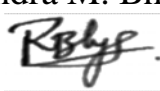

	34	Distance between fuse outlet & panel surface	125 mm (Minimum)
	35	Control terminals for CTs	Stud type with disconnecting facilities
	36	Control terminals for Voltage & other circuits	Stud type
	37	Illumination and Indicating Bulb	LED
	38	Continuous rated operating voltage	440 volt +/- 10%
	39	High voltage withstand capacity	2000 volt at 50 Hz for 1minute
	40	Insulation resistance ph-ph & ph-earth	Minimum 10MOhm with 500V Megger
	41	Labels & name plates	As per Specifications
	42	Surface preparation for painting	Sand blasting or 7 tank process
	43	Painting	Sand blasting or 7 tank process. Light grey shade No 631 of IS-5 Powder coated epoxy paint min thickness 120 micron
	44	Power Supply Socket	5A/15A Plug point socket to be provided
	45	Breaker Barrier	Breaker must have a metallic removable sheet from the front side which will act as a barrier between operator and the breaker. Provision must be given for breaker operation to be done through this barrier.
	46	Branding Plate	All supplied Units shall be fitted with engraved metallic logo of Tata Power on the front side. The Tata Power Co Ltd to be mentioned below the logo with clear font and Dimension 12*12 Inches. * Refer Annexure 2
	47	Panel Dimensions (Min depth of 900 mm)	L X D X H
	48	Numerical Relay	Ashida (ADR 241S) with 4 Element
	49	Bus-bar phase barriers/ Phase separators (R-Y & Y-B)	FRP insulating sheet - (to be placed near to the phase bus-bar) (min 3 mm thickness) shall be provided between bus-bars, so as to ensure that there is no accidental contact with any live parts. (65 mm width)

Rev No.	Prepared By & Date	Checked By & Date	Approved for Issue By & Date
R00	Yash M. Mane 	Ajay V. Potdar 	Ravindra M. Bhanage 
	11/01/2024	11/01/2024	11/01/2024

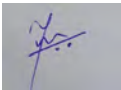

5.0

**GENERAL
CONSTRUCTION**

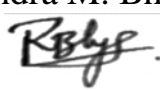
- 1) The feeder pillar frame shall be fabricated using suitable mild steel structural section or pressed and shaped Cold Rolled Closed Annealed (CRCA) sheet of thickness 3 mm.
- 2) Frames shall be enclosed by CRCA sheet of thickness 3mm, smoothly finished, levelled and free from flaws. Doors and cover shall be made of CRCA sheet of thickness not less than 2.5mm. Stiffeners shall be provided, wherever necessary. Gland plates shall be of Hot Rolled Closed Annealed (HRCA) thickness not less than 3 mm. alternatively gland can also be provided between two angles so that removal of gland is easy. The dimension of base frame should be 75mm X 40mm X 5 mm.
- 3) The panel shall be of metal enclosed and outdoor type, support frame mounted type with canopy of adequate slope to avoid water accumulation. Degree of protection shall be IP 54.
- 4) Breaker compartment and fuse compartment should be separated by metallic sheet; the same should be split suitably in order to avoid local heating due to eddy currents generated by three phase bus bars crossing through the same sheet. The breaker compartment should be in center of panel & Outgoings shall be on both the sides of breaker compartment.
- 5) The panel shall be of dust and vermin proof construction and of self-cooled design with adequate louvers on sides and top portion. The louvers shall have fine wire mesh made of brass. The minimum depth of panel shall be 900 mm.
- 6) Labels on the front and rear indicating the panel designation, phase marking and danger signs shall be provided. Single Line Diagram & feeder details shall be engraved and pasted on inside of panel.
- 7) Danger boards shall be provided in local languages on the Hylam sheet below breaker and on front & rear cover with red background and with white letters.
- 8) Hinged doors of lift off type, with concealed type with brass type hinges and captive screws shall be provided on the front side & Back side. Adequate numbers of door hinges shall be provided and should be durable and easy in operation. All doors shall be provided with padlocking facility. The design of doors should permit inter-changeability. The back-side doors shall have nut and bolt arrangement. All Hinged doors shall be connected to the earth terminal with 2.5 Sq.mm braided copper wires.
- 9) Cable entry facilities at bottom of panel and removable gland plates of size suitable to accommodate incoming & outgoing cables of sizes, 4 Core 300 Sq mm 1.1 KV XLPE Cable, shall be provided at required locations.
- 10) Distance between Gland plate and cable termination of Air Circuit Breaker should be minimum 600mm.
- 11) The panel shall be provided with gasket all around the perimeter of covers, gland plates, removable covers and doors.
- 12) ACB termination shall be with tinned copper or tinned aluminium Bus Bar. Wherever required bimetallic washer to be provide, if bare copper terminal is provided.

Rev No.	Prepared By & Date	Checked By & Date	Approved for Issue By & Date
R00	Yash M. Mane 	Ajay V. Potdar 	Ravindra M. Bhanage 
	11/01/2024	11/01/2024	11/01/2024

- 13) Busbars shall be of aluminium with Bakelite shrouding, rated for 2000 A, 50 kA for 1 sec and shall have adequate cross section to carry the rated continuous and short time current. Main Bus bar should be continuous/ without any joint. All bus bars, bus taps and joints shall be PVC taped. Neutral bus bar shall be provided on read side & rated for full bus bar rating.
- 14) The ACBs shall be mechanical operated fixed type 3 Pole with shunt trip coil without any microprocessor protection release. Ashida make (ADR41S) relay to be provided for tripping the breaker with Overcurrent & earth fault protection. Spare ACB contacts for shunt trip should be provided.**
- 15) All fuses shall be of the HRC cartridge type mounted on plug-in type fuse bases having a prospective current of not less than 80 kA.
- 16) Phase to phase clearance of 25mm and Phase to Neutral / Earth clearance of 20mm shall be provided in the panel.
- 17) Distance between centre to centre should be minimum 150 mm between each fuse outlet and 125 mm between fuse outlet and body of panel to be maintained.
- 18) The panel shall be provided with two separate earthing terminals connected to earth bus.
- 19) All instruments shall be connected to the earth terminal using 650V grade PVC insulated 2.5 sq mm stranded tinned copper earthing conductor. All Earthing should be routed properly along with body of panel.
- 20) All hinged doors, Covers, Gland Plates shall be connected to the earth terminal, with the help of braided copper conductors of adequate size. Flat earth bus should be protruded out for connection of external earth
- 21) Eyebolt of suitable sizes shall be provided for lifting arrangements.
- 22) All wiring shall be carried out with 650V grade PVC insulated stranded copper conductors of adequate sizes to suit the rated circuit current.
- 23) The panel shall be powder coated with light shade grade no 631 of IS 5.
- 24) Required number of foundation bolts shall be supplied with the panel.
- 25) Control fuses with control terminals for external cable connections shall be in the breaker chamber only.
- 26) The control terminals shall be as follows:
- Stud type with disconnecting facilities for CT circuits
 - Stud type for voltage and other circuits.
- 27) Fuse bases shall have adequate contact surface with the bus bars provided to ensure that no local heating takes place.
- 28) Lighting System in Feeder Pillar should be LED based.

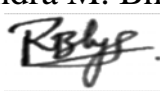
Rev No.	Prepared By & Date	Checked By & Date	Approved for Issue By & Date
R00	Yash M. Mane 	Ajay V. Potdar 	Ravindra M. Bhanage 
	11/01/2024	11/01/2024	11/01/2024

6 Way LT Panel: Representative GA drawing & SLD-

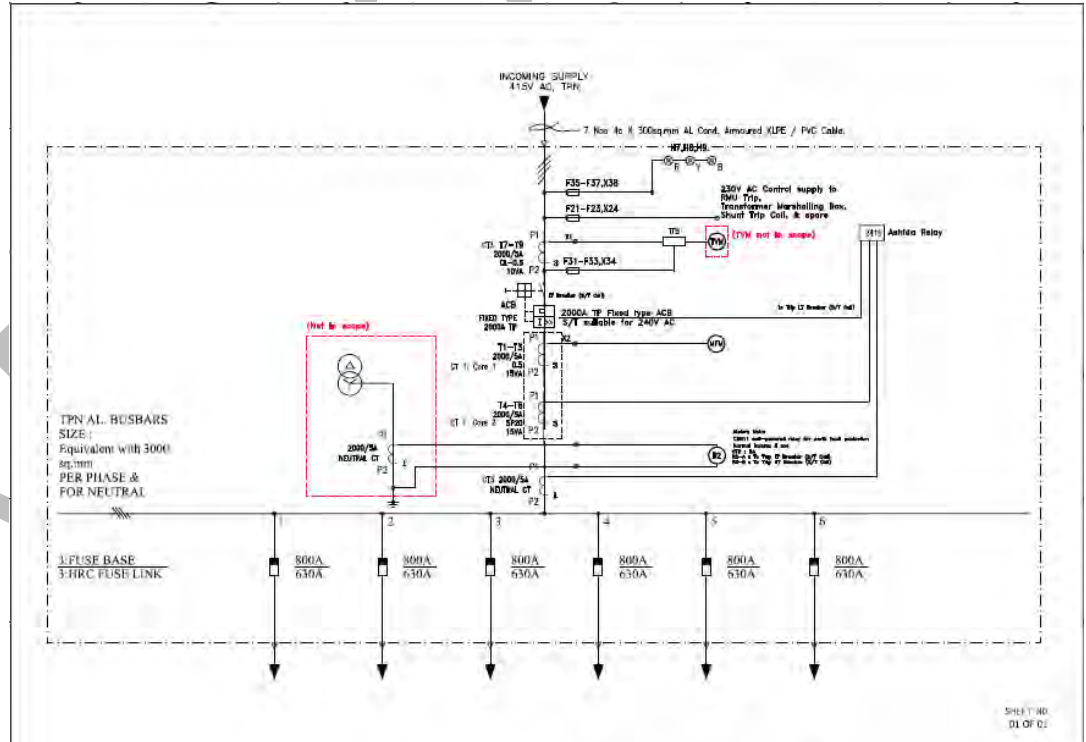
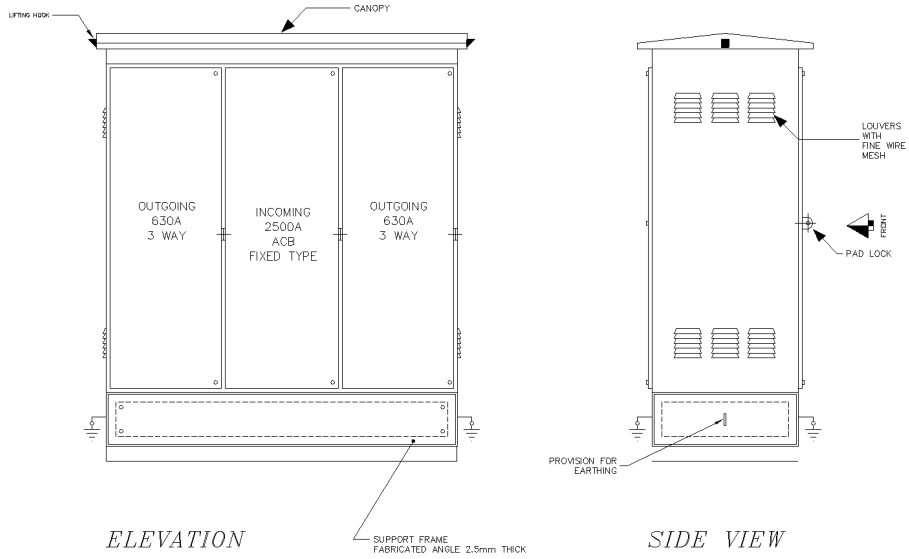

Rev No.	Prepared By & Date	Checked By & Date	Approved for Issue By & Date
R00	Yash M. Mane 	Ajay V. Potdar 	Ravindra M. Bhanage
	11/01/2024	11/01/2024	11/01/2024

Control Wiring Diagram:

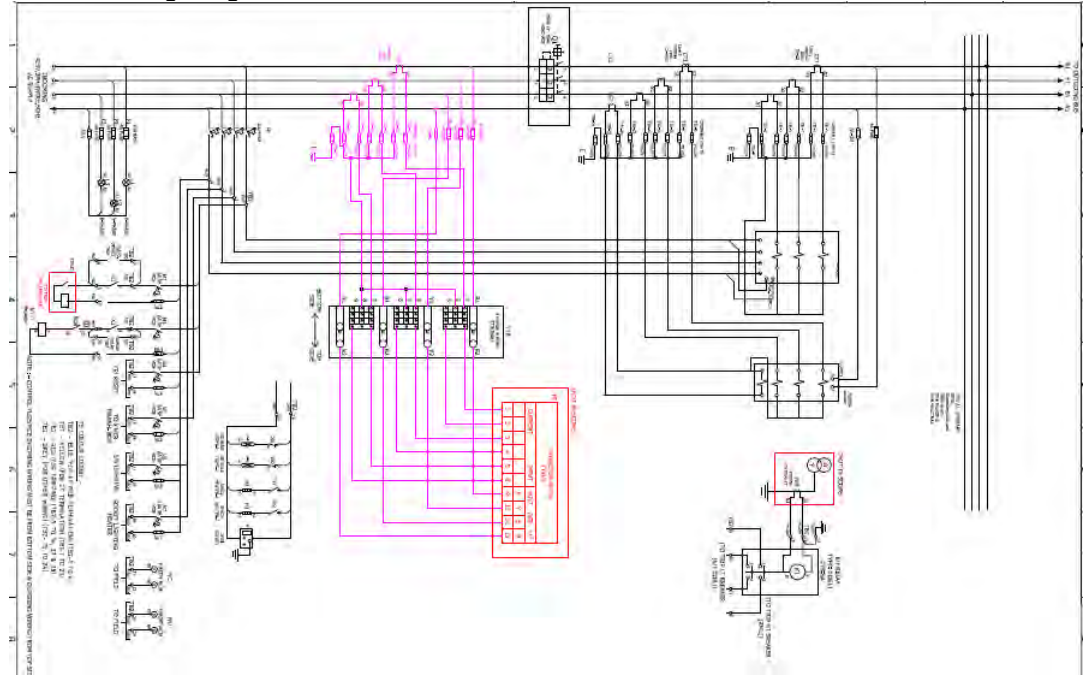

5.1 Specific Requirements

- a) The LT Panel should be 6 way type having 6 Nos. outlets per phase respectively as per tender requirement.
- b) Material Quality Plan, general arrangement drawing and single line diagram of the feeder pillar to be approved before manufacturing.
- c) Adequate cable termination shall be provided as follows

Sr. No.	TYPE	UoM	No. of Cable	Description
1	2000A Incomers	1No.	7	1.1KV, 4C, 300 sqmm AL cond. Armoured XLPE/PVC Cable
2	6 Way Panel 630 A Fuse Outgoing	6 No. Per outgoing	2	1.1KV, 4C, 300 sqmm AL cond. Armoured XLPE/PVC Cable

- d) 2000A Incomer shall be provided with resin cast CTs of ratio 2000/5A for metering & protection.
 3 nos dual core CT 2000A/5A, Core 1: 0.5 CI, Core 2: 5P20, 15 VA, to be used for MFM.
 3 nos single core CT 2000A/5A, 0.5, 15 VA, to be used for Energy metering.
 1 no single core CT 2000A/5A, 5P20, 15 VA, to be used for neutral unbalance protection.

Rev No.	Prepared By & Date	Checked By & Date	Approved for Issue By & Date
R00	Yash M. Mane 	Ajay V. Potdar 	Ravindra M. Bhanage
	11/01/2024	11/01/2024	11/01/2024

- e) All CT termination should be round plug type. No CT shorting arrangement to be provided. (As per SLD)
- f) Secondary wiring shall be carried out with 1.1KV grade PVC insulated stranded copper conductor of 2.5 Sq. mm for CT circuits and 2.5 Sq. mm for PT and other circuits. All wires will be colour coded.

Sr. No.	Equipment	Color	Nomenclature of TBs	Types of TBs
1.	TBs of 4 Pole MCB Termination	Blue	TB2	Droppable
2.	TBs for CT Termination	Yellow	TB1	Droppable
3.	TBs for Tripping	Red	TB2	Droppable
4.	All others	Default	TB2	Normal

- g) The feeder pillar panel shall be provided with Alstom Make CDG11 self-powered relay for earth fault protection. The relay type is normal inverse with 3 sec with E/F setting of 0.5 to 2 A.
- h) Test terminal box for Energy Metering should be Front Connection, Screw Type (4SF), 50 A to be provided and the convention of the wiring in the TTB should be Incoming from the bottom side and outgoing to Meter from top side. There must not be any partition between Relay & metering box in LV compartment. It should be single door compartment. No lugs shall be provided for wires to meter, TTB, and Fuses (PT secondary). Sealing arrangement to be provided for Energy Meters. Inspection glass (Transparent Toughened Glass) to be provided for viewing of meter.
- i) All Protection/ control wiring must terminate in LV compartment.
- j) Provision to be provided for mounting the energy meter with max dimensions as L x B x D: 360 x 200 x 200 mm (Energy meter will be supplied by TPC). The relay and energy meter shall be installed in the breaker compartment with suitable partitions. The relays shall be supplied by the vendor.
- k) The LT panel shall be equipped with shrouded type anti condensation space heaters with thermostat, internal light with switch & 5A/15A metal clad general-purpose plug socket.
- l) The following separate control circuit 20A, 4 pole MCB duly wired up to terminal block for purchaser's use shall be provided before the circuit breaker in feeder pillars leading to following single pole MCB with neutral links (refer SLD):

Phase and neutral for 230V supply to RMU. (6A)

Phase and neutral for 230V supply to Transformer marshalling box. (6A)

Phase and neutral for external shunt trip coil (6A)



Phase and neutral for FPI reset (6A)

Separate 16A, DP MCB duly wired for Auxiliary supply for LT panel for following purpose,

Phase and neutral for substation lighting (6A)

Phase and neutral for Socket (15A)/ Heater circuit

Phase and neutral for Ashida overcurrent relay (4A)

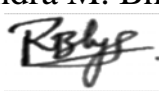
Rev No.	Prepared By & Date	Checked By & Date	Approved for Issue By & Date
R00	Yash M. Mane 	Ajay V. Potdar 	Ravindra M. Bhanage 
	11/01/2024	11/01/2024	11/01/2024

m) The following separate control fuses with neutral links duly wired out to a set of stud type link terminals for purchaser's use shall be provided before the circuit breaker in feeder pillars Control fuse Incoming wiring must be from bottom side & Outgoing wiring from top side. (refer SLD):

Three phase and neutral for metering circuit.

Three Phase and neutral for indication lamp

n) Locking should be of welded type. Earthing jumpers to be provided for all the doors. Louvers with stainless steel wire mesh to be provided on body side and cover plate.

o) Makes of various bought out items shall be limited to the following:

Sr. No.	Items	Approved Make
1	ACB	Schneider/ L&T/ Siemens/ C&S/ ABB/ Eaton
2.	CT	Reco/Newtek/Pragati/Kappa/ECS/Adcon

p) Flexible copper braiding should be provided on the doors. Neutral bus shall be connected with earth bus. All control cable should be multi stranded and FRLS. CT ISF should be less than or equal to 5. Close and Open status of the breaker should be available on SCADA through spare auxiliary contact and on LT panel through LED Lamp.



q) The fuses provide should be of knife type and same should be removable with the help of fuse puller. There shall be no obstruction during removal of outgoing fuses by fuse puller.

r) The safety locking facility to be provided for putting three nos. of safety locks.

s) Panel minimum width in mm: 900 mm

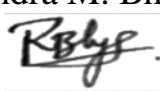

t) The breaker manufacturer to provide the complete support in terms of training; hand holding to our Testing and O&M staff. The breaker manufacturer to give the support service for next 10 years.

u) The robust isolating arrangement in the OG fuse compartment to be made.

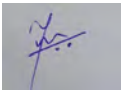

Rev No.	Prepared By & Date	Checked By & Date	Approved for Issue By & Date
R00	Yash M. Mane 	Ajay V. Potdar 	Ravindra M. Bhanage 
	11/01/2024	11/01/2024	11/01/2024

The Tata Power Company Limited		TECHNICAL SPECIFICATION OF 6 Way 2000 A LT Panel
ENSE-DS-2032-R00		Date of Issue: 11/01/2024

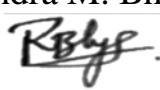
6.0	NAME PLATE AND MARKING	<p>6.1 Name plate- On front door top left side-showing</p> <ol style="list-style-type: none"> 1) Purchaser name & PO number. 2) Manufacturer name 3) Month / year of manufacturing 4) 'Property of Tata Power' <p>6.2 Marking for panel earth stud- Black letter 'E', on riveted Al label</p> <p>6.3 Danger board in English & local language, riveted on doors- White colour background with red lettering on 1.6mm thick Al plate.</p> <p>6.4 SLD shall be engraved & pasted on inside of door.</p> <p>6.5 CT Serial Nos., Ratio & ACB Serial Nos. to be written on doors with marker pen.</p> <p>6.6 Separate metallic name plate with Tata Power Logo of Dimension 12*12 Inches in clear font as shown in Annexure-2.</p>
7.0	TESTS	<p>All routine, acceptance & type tests shall be carried out in accordance with the relevant IS/IEC. Following tests shall be necessarily conducted on the 'Feeder Pillar' in addition to others specified in IS/IEC standards.</p> <p>*In case of any conflict on any technical particular, the stricter requirement mentioned in the relevant standard shall be valid.</p>
7.1	Type test	<p>Type test - Only type tested components – ACBs, Fuses, Insulators & aluminium bus bar shall be accepted. Following type test shall be carried out on the assembly.</p> <ol style="list-style-type: none"> a) Verification of temperature-rise limits – Clause 8.2.1 of IS 8623 b) Verification of dielectric properties – Clause 8.2.2 of IS 8623 c) Verification of short-circuits strength – Clause 8.2.3 of IS 8623 d) Verification of continuity of the protective circuit – Clause 8.2.4 of IS 8623 e) Verification of clearance and creepage distances – Clause 8.2.5 of IS 8623 f) Verification of mechanical operation – Clause 8.2.6 of IS 8623 f) Verification of degree of protection – Clause 8.2.7 of IS 8623
7.2	Routine test	<p>Acceptance & routine test- (Inspection test witness by purchaser as per approved Quality Assurance Plan)</p> <ol style="list-style-type: none"> 1) Visual inspection, dimension checks & paint thickness checks. 2) Bill of material check 3) Insulation resistance test 4) High voltage test 5) Operational check 6) Verification of dielectric properties 7) Tolerances on panel dimensions- Maximum +/- 5mm 8) No negative tolerance on bus bar dimensions & bus bar clearances 9) Stability test shall be conducted on all Panels, to ensure there shall be no tripping in case of unbalance current on earth fault function.

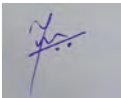

Rev No.	Prepared By & Date	Checked By & Date	Approved for Issue By & Date
R00	Yash M. Mane 	Ajay V. Potdar 	Ravindra M. Bhanage 
	11/01/2024	11/01/2024	11/01/2024

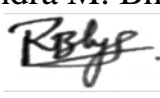
7.3	Acceptance test	<ol style="list-style-type: none"> 1) Visual inspection & dimensional check 2) Verification of clearance and creepage distance 3) Paint thickness check 4) Wiring checks 5) Insulation resistance test 6) HV test 7) Stability test on all Panels, to ensure there shall be no tripping in case of unbalance current on earth fault function. 8) 1 unit from 1st lot shall be tested for Temperature rise test with ACB and fuses. (Bidder to arrange for the same, either in factory or in external lab)
8.0	TYPE TEST CERTIFICATE	<p>The Bidder shall furnish the type test certificates for the tests as mentioned above as per the corresponding standards. Type Test to be conducted on similar Design/ rating panel. All the tests shall be conducted at CPRI / ERDA/ NABL as per the relevant standards. Type test should have been conducted in certified Test Laboratories during the period not exceeding 10 years from the date of opening the bid.</p> <p>Type tests shall have been conducted in certified Test laboratories during the period not exceeding 10 years from the date of opening the bid. In case if type test conducted beyond 10 years then bidder to certify on letter head of parent OEM that no design change & no manufacturing plant change occurred from type tested product.</p> <p>In the event of any discrepancy in the test reports, i.e. any test report not acceptable or any/all type tests (including additional type tests, if any) not carried out, same shall be carried out without any cost implication to TATA POWER.</p>
9.0	PRE-DISPATCH INSPECTION	<p>The Material shall be subject to inspection by a duly authorized representative of the TATA POWER COMPANY. Inspection may be made at any stage of manufacture at the discretion of the Purchaser and the equipment, if found unsatisfactory as to workmanship or material, the same is liable to rejection. Bidder shall always grant free access to the places of manufacture to TATA POWER COMPANY `s representatives when the work is in progress. Inspection by the TATA POWER COMPANY or its authorized representatives shall not relieve the Bidder of his obligation of furnishing equipment in accordance with the specifications. TATA POWER COMPANY authorized representatives shall have the right to inspect the design, materials and workmanship and to report thereon, at any stage of manufacture, if found necessary. All facilities shall be extended to our representatives for witnessing the tests. Due notice shall be given to us to enable us to depute our representatives for stage inspection.</p> <p>Material shall be dispatched after specific MDCC (Material Dispatch Clearance Certificate) is issued by TATA POWER COMPANY.</p> <p>Five certified copies of all test certificates including type tests, sample test certificates shall be sent to us for our approval prior to dispatch of materials.</p> <p>Following documents shall be sent along with material</p> <ol style="list-style-type: none"> a) Test reports b) MDCC issued by TATA POWER COMPANY c) Invoice in duplicate d) Packing list e) Drawings & catalogue f) Delivery Challan g) Other Documents (as applicable).



Rev No.	Prepared By & Date	Checked By & Date	Approved for Issue By & Date
R00	Yash M. Mane 	Ajay V. Potdar 	Ravindra M. Bhanage 
	11/01/2024	11/01/2024	11/01/2024

The Tata Power Company Limited		TECHNICAL SPECIFICATION OF 6 Way 2000 A LT Panel
ENSE-DS-2032-R00		Date of Issue: 11/01/2024

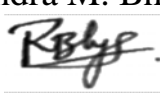
10.0	INSPECTION AFTER RECEIPT AT STORE	<p>The material received at TPC, Mumbai store shall be inspected for acceptance and shall be liable for rejection, if found different from the reports of the pre-dispatch inspection or any other parameters observed after delivery.</p> <p>The material should be delivered at TPC, Mumbai stores within 45 days from the date of manufacturing, same shall be checked during delivery and overdue material shall not be accepted. Bidders to plan the delivery accordingly.</p> <p>Bidders to attend and rectify the same at his own cost. The material shall be accepted in stores only after rectification of any observed flaw. The delay in rectification shall lead to any contractual penalty.</p> <p>Billing shall be processed only after acceptance of the material.</p>
11.0	GUARANTEE	<p>Bidder shall stand guarantee towards design, materials, workmanship & quality of process / manufacturing of items under this contract for due and intended performance of the same, as an integrated product delivered under this contract.</p> <p>In the event any defect is found by the TATA POWER COMPANY up to a period of at least 12 months from the date of commissioning or 24 months from the date of last supplies made under the contract whichever is later, (the time scale of 12/24 months could be enhanced subject to mutual agreements) Bidder shall be liable to undertake to replace/rectify such defects at its own costs, within mutually agreed time frame, and to the entire satisfaction of the Purchaser, failing which the TATA POWER COMPANY will be at liberty to get it replaced/rectified at Bidder's risks and costs and recover all such expenses plus the Purchaser's own charges (@ 20% of expenses incurred), from the Bidder or from the " Security cum Performance Deposit" as the case may be.</p> <p>In case of GP failure, BA shall report at site within 48 hours from intimation and arrange for rectification of fault within a mutually agreed time. In case rectification at site is not possible then alternative arrangement (replacement) to be made by BA within 15 days of intimation of failure.</p> <p>Bidder shall further be responsible for 'free replacement' for another period of THREE years from the end of the guarantee period for any 'Latent Defects' if noticed and reported by the Purchaser.</p>
12.0	PACKING AND TRANSPORT	<p>Bidder shall ensure that the item covered under this specification shall be packaged for rail/road transport in a manner so as to protect the equipment from damage in transit.</p> <ol style="list-style-type: none"> 1) Packing protection- Against shocks, vibration & corrosion, damages during transportation 2) Packing identification labels, to show purchaser name, PO number, quantity of panels, Panel type, Manufacturer serial number 3) Handling instruction- To be marked on packing boxes. 4) Bidders should prefer to use recyclable & environmentally friendly materials for packing. 5) No single use plastic to be used. 6) Packing should be done with environment friendly recyclable materials.
13.0	TENDER SAMPLE	Not Applicable

Rev No.	Prepared By & Date	Checked By & Date	Approved for Issue By & Date
R00	Yash M. Mane 	Ajay V. Potdar 	Ravindra M. Bhanage 
	11/01/2024	11/01/2024	11/01/2024

14.0	QUALITY CONTROL	<p>The Bidder shall submit with the offer Quality assurance plan indicating the various stages of inspection, the tests and checks which will be carried out on the material of construction, components during manufacture and bought out items and fully assembled component and equipment after finishing. As part of the plan, a schedule for stage and final inspection within the parameters of the delivery schedule shall be furnished.</p> <p>TATA POWER COMPANY shall reserve the sole rights for the type test of a random sample from the lot and in case of any discrepancy or deviation from the Type test certificates submitted along with the Bid; the complete Lot shall be rejected.</p> <p>TATA POWER COMPANY representative or its nominated representative shall have free access to the Bidder's works to carry out inspections.</p> <p>If anything missing in QAP and required as per other clauses of this document, bidder is liable to perform the same without cost implication.</p>
15.0	MINIMUM TESTING FACILITIES	<p>Bidder shall have adequate in-house testing facilities for carrying out all routine tests & acceptance tests as per relevant International / Indian standards and as specified above.</p>
16.0	MANUFACTURING ACTIVITIES	<p>The successful bidder will have to submit first GTP & Drawing with 7 days from placement of outline agreement for approval and complete the approval process within 14 days of outline agreement. The date of Code -2/ Code-1 approval given by TATA Power will be treated as first day for assessment of LD (if applicable).</p>
17.0	SPARES, ACCESSORIES, AND TOOLS	<p>Keys of door</p>
18.0	DRAWING AND DOCUMENTS	<p>Following drawings and documents shall be prepared based on TATA POWER COMPANY specifications and statutory requirements and shall be submitted with the bid. All the documents & drawings shall be in English language</p> <ul style="list-style-type: none"> a) Completely filled in Technical Particulars b) General description of the equipment and all components including brochures. c) General arrangement drawing. d) Bill of material e) Experience List f) Type test certificates g) Any other technical document, if required
19.0	SCHEDULE "A" GUARANTEED TECHNICAL PARTICULARS	<p>Bidders to comply for all above requirement of specifications clauses & submit signed and stamp copy as technical compliance document.</p>

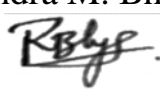
Rev No.	Prepared By & Date	Checked By & Date	Approved for Issue By & Date
R00	Yash M. Mane  11/01/2024	Ajay V. Potdar  11/01/2024	Ravindra M. Bhanage  11/01/2024

The bidders shall set out all deviations from this specification, Clause by Clause in this schedule. Unless specifically mentioned in this schedule, the tender shall be deemed to confirm the purchaser's specifications.

(TO BE ENCLOSED WITH THE BID)

All deviations from this specification shall be set out by the bidders, clause by Clause in this schedule. Unless specifically mentioned in this Schedule, the tender shall be deemed to confirm the purchaser's specifications:

Sr.No.	Clause No.	Details of deviation with justifications

20.0



SCHEDULE "B" DEVIATIONS

We confirm that there are no deviations apart from those detailed above.

Seal of the Company

Signature :

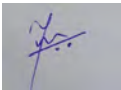
Designation :

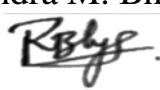
Rev No.	Prepared By & Date	Checked By & Date	Approved for Issue By & Date
R00	Yash M. Mane  11/01/2024	Ajay V. Potdar  11/01/2024	Ravindra M. Bhanage  11/01/2024



The Tata Power Company Limited		TECHNICAL SPECIFICATION OF 6 Way 2000 A LT Panel
ENSE-DS-2032-R00		Date of Issue: 11/01/2024

Annexure – 1

Inspection Testing Plan

1. Visual inspection & dimensional check
2. Verification of clearance and creepage distance
3. Paint thickness check
4. Wiring checks
5. Insulation resistance test
6. HV test
7. Stability test on all Panels, to ensure there shall be no tripping in case of unbalance current on earth fault function
8. 1 unit from 1st lot shall be tested for Temperature rise test with ACB and fuses. (Bidder to arrange for the same, either in factory or in external lab)

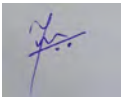
TATA POWER

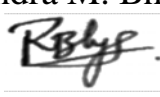
Rev No.	Prepared By & Date	Checked By & Date	Approved for Issue By & Date
R00	Yash M. Mane 	Ajay V. Potdar 	Ravindra M. Bhanage 
	11/01/2024	11/01/2024	11/01/2024

Annexure – 2

Tata power Branding Name plate -

Separate metallic name plate with Tata Power Logo of Dimension 12*12 Inches in clear font as shown below.

Relationship between the two marks- size

The Tata and Tata Power Marks are always used in conjunction with each other, never appearing in isolation on Tata Power communication.

The height of the letter T of Tata (T-height) is the basic measure for all sizes and proportions.

The rounded measure 2T in height, is separated from the Tata lettering by a distance of 1/2T.

The T height of both, the Tata and the Tata Power Marks is to be the same, except in exceptional cases on approval from the Corporate Communications team.





Relationship between the two marks- positioning

The two marks can appear stacked, which is the preferred placement, or linear, by the side of one another.

Centre aligned - Stacked (Preferred)

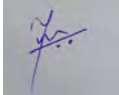

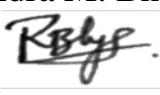

Rev No.	Prepared By & Date	Checked By & Date	Approved for Issue By & Date
R00	Yash M. Mane 	Ajay V. Potdar 	Ravindra M. Bhanage 
	11/01/2024	11/01/2024	11/01/2024

The Tata Power Company Limited		TECHNICAL SPECIFICATION OF 6 Way 2000 A LT Panel
ENSE-DS-2032-R00		Date of Issue: 11/01/2024

Annexure – 3

Reference drawings

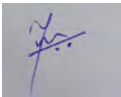
TATA POWER

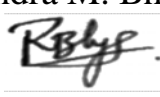
Rev No.	Prepared By & Date	Checked By & Date	Approved for Issue By & Date
R00	Yash M. Mane 	Ajay V. Potdar 	Ravindra M. Bhanage 
	11/01/2024	11/01/2024	11/01/2024

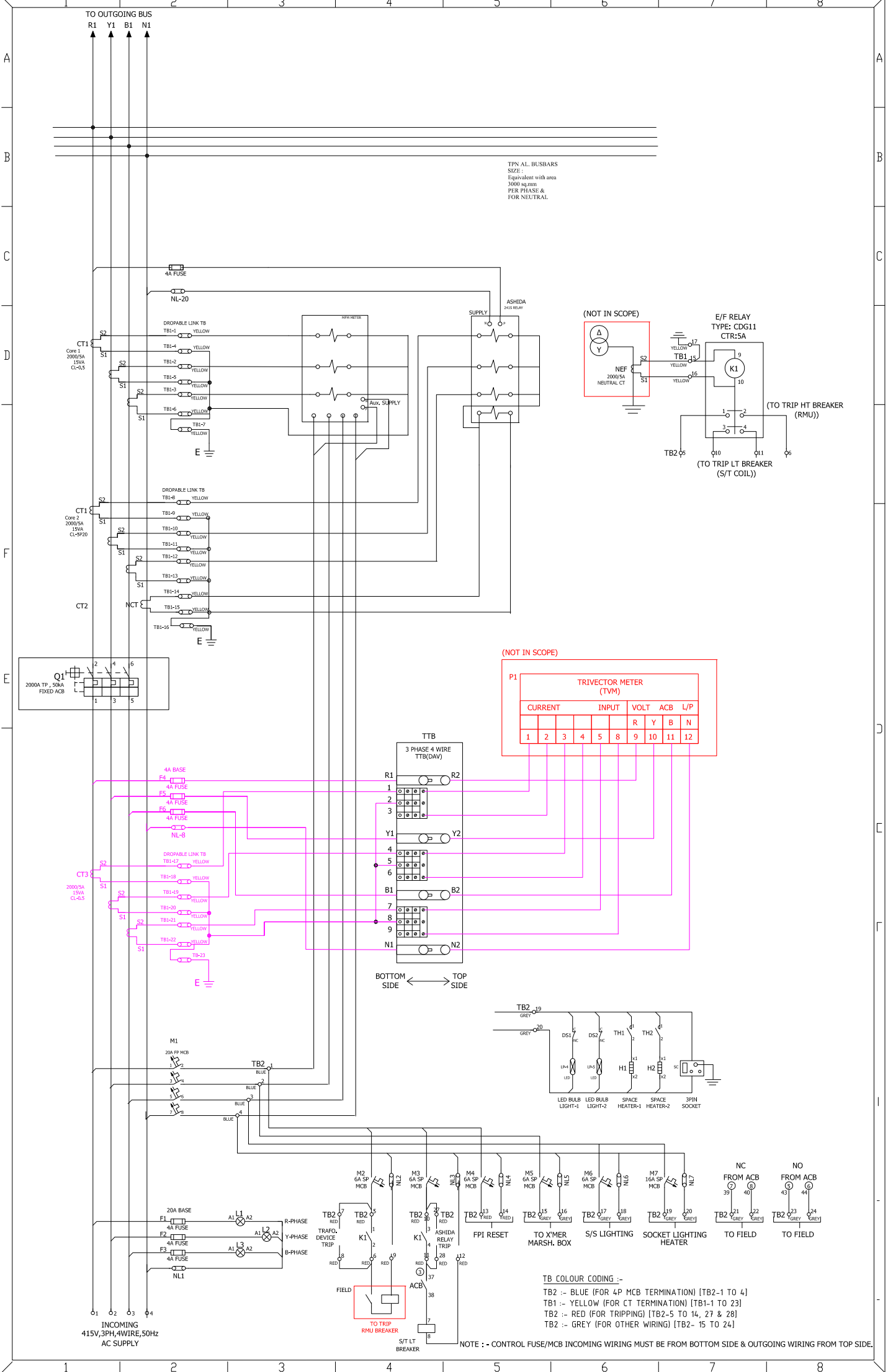

TPN AL. BUSBARS
SIZE :
Equivalent with area
3000 sq mm
PER PHASE &
FOR NEUTRAL.

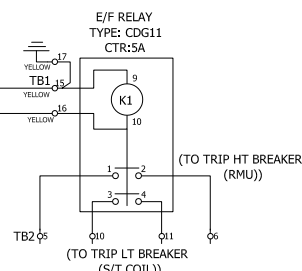
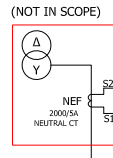

(NOT IN SCOPE)

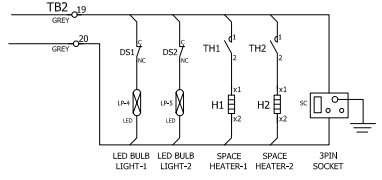
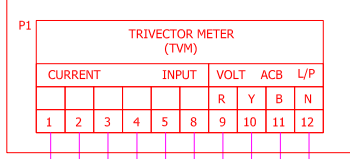

TB COLOUR CODING :-
TB2 :- BLUE (FOR 4P MCB TERMINATION) [TB2-1 TO 4]
TB1 :- YELLOW (FOR CT TERMINATION) [TB1-1 TO 23]
TB2 :- RED (FOR TRIPPING) [TB2-5 TO 14, 27 & 28]
TB2 :- GREY (FOR OTHER WIRING) [TB2- 15 TO 24]

INCOMING SUPPLY
415V AC, TPN

7 Nos 4c X 300sq.mm AL Cond. Armoured XLPE / PVC Cable.

H7,H8,H9.

F35-F37,X38

F21-F23,X24

230V AC Control supply to
RMU Trip,
Transformer Marshalling Box,
Shunt Trip Coil, & spare

CT3 T7-T9
2000/5A
CL-0.5
10VA

P1

P2

X1

X2

LT Breaker (S/T Coil)

ACB
FIXED TYPE
2000A TP

P1

P2

T1-T3
2000/5A
0.5
15VA

T4-T6
2000/5A
5P20
15VA

P1

P2

CT3 2000/5A
NEUTRAL CT

P1

P2

2000/5A
NEUTRAL CT

P1

P2

TTB

(TVM not in scope)

241S Ashida Relay

To Trip LT Breaker (S/T Coil)

(MFM)

(R2)

Alstom Make
CDG11 self-powered relay for earth fault protection
Normal inverse 3 sec
CTR : 5A
R2-A : To Trip LT Breaker (S/T Coil)
R2-B : To Trip HT Breaker (S/T Coil)

(Not in scope)

TPN AL. BUSBARS
SIZE :
Equivalent with 3000
sq.mm
PER PHASE &
FOR NEUTRAL

3:FUSE BASE
3:HRC FUSE LINK

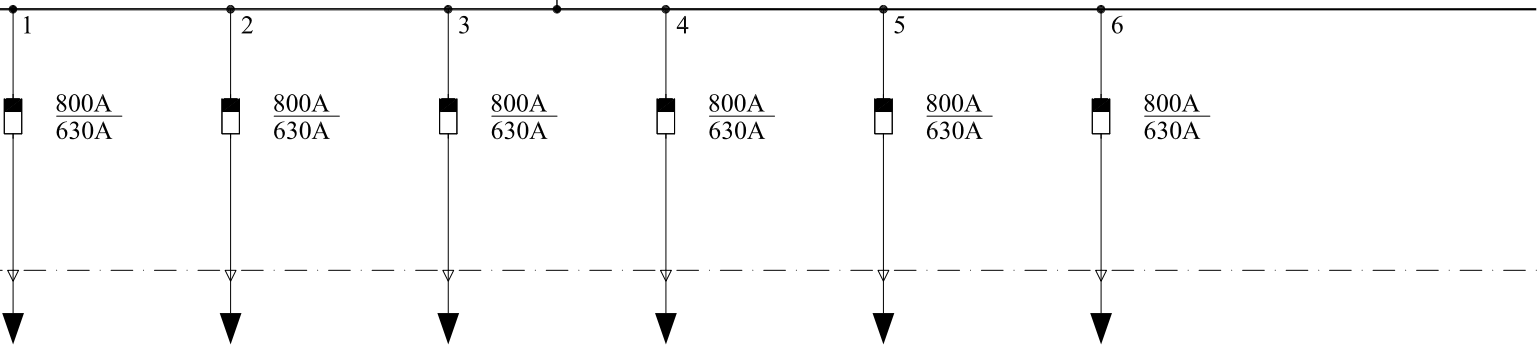

TECHNICAL SPECIFICATION

8 Way 3200 A LT Panel



The Tata Power Company Ltd.
Engineering Services (ENSE),
Distribution Division,
Senapati Bapat Marg,
Lower Parel,
Mumbai – 400013
Maharashtra



The Tata Power Company Limited		TECHNICAL SPECIFICATION OF 8 Way 3200 A LT Panel
ENSE-DS-2033-R00		Date of Issue: 11/01/2024

TECHNICAL SPECIFICATION COVER SHEET

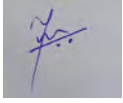
Document No: ENSE-DS-2033-R00

Document Title: Technical SPECIFICATION OF 8 Way 3200 A LT Panels

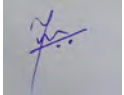

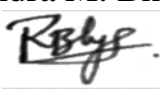
R00	ENSE-DS-2033-R00 (For Tendering Purpose)	11/01/2024	YMM		AVP		RMB	
R2	SPEC-NET-Feeder Pillar-3200A	02/03/23	MY	-sd-	VK	-sd-	SBM	-sd-
Rev No.	Remarks	Date	Initials	Sign	Initials	Sign	Initials	Sign
			Prepared By		Reviewed By		Approved & Issued By	

Rev No.	Prepared By & Date	Checked By & Date	Approved for Issue By & Date
R00	Yash M. Mane 	Ajay V. Potdar 	Ravindra M. Bhanage 
	11/01/2024	11/01/2024	11/01/2024

The Tata Power Company Limited		TECHNICAL SPECIFICATION OF 8 Way 3200 A LT Panel
ENSE-DS-2033-R00		Date of Issue: 11/01/2024

CONTENTS

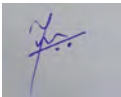
	<u>PAGE NO</u>
1.0 SCOPE	4
2.0 APPLICABLE STANDARDS	4
3.0 CLIMATIC CONDITIONS OF THE INSTALLATION	5
4.0 GENERAL TECHNICAL REQUIREMENTS	5
5.0 GENERAL CONSTRUCTIONS	9
6.0 NAME PLATE & MARKINGS	15
7.0 TESTS, ROUTINE & ACCEPTANCE TESTS	15
8.0 TYPE TEST CERIFICATES	16
9.0 PRE-DISPATCH INSPECTION	16
10.0 INSPECTION AFTER RECEIPT AT STORE	17
11.0 GUARANTEE	17
12.0 PACKING AND TRANSPORT	17
13.0 TENDER SAMPLE	17
14.0 QUALITY CONTROL	18
15.0 MINIMUM TESTING FACILITIES	18
16.0 MANUFACTURING ACTIVITIES	18
17.0 SPARES, ACCESSORIES AND TOOLS	18
18.0 DRAWING AND DOCUMENTS	18
19.0 SCHEDULE "A" GUARANTEED TECHNICAL PARTICULARS	18
20.0 SCHEDULE "B" DEVIATIONS	19
+ ANNEXURE 1, 2 & 3	

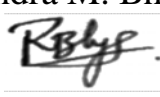
Rev No.	Prepared By & Date	Checked By & Date	Approved for Issue By & Date
R00	Yash M. Mane 	Ajay V. Potdar 	Ravindra M. Bhanage 
	11/01/2024	11/01/2024	11/01/2024

1.0 SCOPE

This specification covers design, engineering, manufacture; shop testing, inspection, painting, packing, and supply of 415V, 3200 A LT Panel with 8 no Outgoing Feeders complete with all accessories for efficient and trouble-free operation of the distribution network for Tata Power Company Limited at Mumbai.

It is not our intent to specify completely herein all details of design and construction of the equipment. However, the equipment shall conform in all respects to high standards of Engineering design and workmanship and shall be capable of performing in a manner acceptable to the purchaser (TPC) who will interpret the meaning of drawings and specification and shall be entitled to reject any work or material which in his judgement is not in full accordance therewith.



All the bought-out items shall be of reputed make and shall be subject to approval by the PURCHASER (TPC) after award of contract.

2.0 APPLICABLE STANDARDS

The equipment shall conform to this specification and latest revision of following codes with all amendments.

	Title	Indian standard
1	IS 8623	Specification for low voltage switchgear
2	IS 12063/ IEC 60529	Classification of degrees of protection provided by Enclosures of Electrical equipment
3	IS 5	Color of ready mixed paints
4	IS 5082	Wrought Aluminium & Al alloy plates & sheets for electrical application
5	IS 2705	Current Transformers
6	IS 2551	Danger Notice plates
7	IS 13703-2	Low voltage fuses for voltage not exceeding 1000 V AC or 1500 V DC. Part 2 Fuses for use by authorized persons
8	IEC 255	Protection Relays
9	IEC 801	Control and monitoring
10	IEC 60947-2 /IS 13947-2	Low Voltage Switchgear & control gear
11	IEC 60269	Low Voltage Fuses

In case of any conflict on any technical particular in the specification, the stricter requirement mentioned in the relevant standard shall be valid.

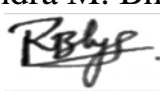
Rev No.	Prepared By & Date	Checked By & Date	Approved for Issue By & Date
R00	Yash M. Mane 	Ajay V. Potdar 	Ravindra M. Bhanage 
	11/01/2024	11/01/2024	11/01/2024

3.0

**CLIMATIC
CONDITIONS OF
THE
INSTALLATION**

1	Maximum ambient temperature	43 deg.C
2	Max. Daily average ambient temp	35 deg.C
3	Min Ambient Temperature	07 deg.C
4	Maximum Relative Humidity	100%
5	Minimum Relative Humidity	40%
6	Average No. of thunderstorm per annum	50
7	Average Annual Rainfall	2380mm
8	Average No. of rainy days per annum	115
9	Rainy months	June to Oct.
10	Altitude above MSL not exceeding	300 meters
11	Average Air Pressure	29.6-inch Hg

Atmosphere is generally laden with mild acid and dust suspended during dry months and subjected to fog in cold months. The design of the equipment and accessories shall be suitable to withstand seismic forces corresponding to an acceleration of 0.1g.

4.0

**GENERAL
TECHNICAL
REQUIREMENTS**

Sr. No	Item Description	Tata Power Requirement
1	Manufacturer	Name
		Manufacturer Address
		Contact telephone no
2	Breaker Rating (ACB)	3200A Manual Fixed Type without any microprocessor relay. 230V AC Shunt tripping coil to be provided.
	Model of ACB	The Model shall be such that current density in current carrying part shall be less than 3 A/sq.mm. (Bidder to mention the model)
	Approved Make	Schneider/ L&T/ Siemens/ C&S/ ABB/ Eaton
3	Main bus bar rating	3200 A
	Bus bar Size for Phase & Neutral	4000 sq.mm for Phase & Neutral
	Earth Bus	1 x 50 x 10 mm GI
4	Type of Installation	Indoor / Outdoor Type
5	No of Incoming feeders	Qty -1no. of 3200A ACB with 10 Nos of 4CX300 sq.mm Al Ar XLPE cables
6	No of outgoing feeders (8 Way)	Quantity -8 Nos of 630A each with 3 nos of 4CX300 sq.mm Al Ar XLPE cables per O/G
7	Panel construction	CRCA sheet steel of thickness 3 mm
8	Panel enclosure class	IP54 - ingress protection

Rev No.

Prepared By & Date

Checked By & Date

Approved for Issue By
& Date

R00

Yash M. Mane

Ajay V. Potdar



Ravindra M. Bhanage

11/01/2024



11/01/2024

11/01/2024

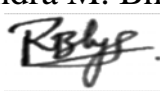

	9	Sheet steel thickness	Doors & Covers - 2.5mm, FRAME - 3mm
	10	Door type for front & rear access	Double door with rear door bolted
	11	Door hinges	Minimum three anti-theft type hinges self-locking type
	12	Padlocking facility	For front door
	13	Master key for all doors	Identical for all panels, 1 no./ panel to be provided
	14	Hardware & Fasteners	All Nuts, Bolts, Washers shall be Hot Dip Galvanized with 80 micron Galvanisation or Alu-Zinc coating. Bolts below 12 mm size shall be SS material.
	14a	Current Carrying part hardware	Each bolt on Bus Bar and Fuse terminal shall be provided with Belleville washer and plain washer. Wherever required bimetallic washers to be provided
	15	Phase & neutral Bus bar	Aluminium grade 19501 (H2) as per IS 5082
		Bus bar size in mm for 3200 A O/G	4000 sq.mm for Phase & Neutral
		3200A ACB Incoming	4000 sq.mm for Phase & Neutral
		ACB O/G LINKS	4000 sq.mm for Phase & Neutral (Dimensions as per feasibility with Breaker palm connection)
	16	Bus bar color coding for R, Y, B & neutral	Heat shrinkable sleeves with color Red, Yellow, Blue & Black respectively
	16 a	Bus Bar Heat shrinkable sleeves	Cross-linked Polyolefin (Bidder to specify thickness)
	17	Main bus bar short circuit withstand capacity	Above 50kA for 1 sec
	18	Permissible maximum temperature rise above ambient of 50°C	Busbar: 45 deg C
		Permissible maximum temperature rise above ambient of 50°C	Terminals: 65 deg C
	19	Bus bar support insulators	As per IS13410 SMC / DMC, 1100V grade
	20	Incoming Cable Size	4C 300 Sq.mm Al Ar XLPE
	21	Outgoing Cable Size	4C 300 Sq.mm Al Ar XLPE
	22	Gland plate at panel bottom	HRCA MS 3mm thickness

Rev No.	Prepared By & Date	Checked By & Date	Approved for Issue By & Date
R00	Yash M. Mane 	Ajay V. Potdar 	Ravindra M. Bhanage 
	11/01/2024	11/01/2024	11/01/2024

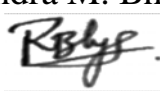
	23	Cable termination clearance	600 mm minimum from gland plate & ACB
	24	Fuse Base	800 A
		Approved Make	L&T / Siemens / Schneider / GE Power Control / Jean Muller / Bussmann / ABB
	25	Fuses (630 A)	HRC plug-in type gG (General Purpose, Fast acting fuse)
		Approved Make	L&T / Siemens / Schneider / GE Power Control / Jean Muller / Bussmann / ABB
	26	CT's for 3200A Incoming Feeder	<p>7 Nos. Single resin cast.</p> <p>a) 3 nos dual core CT's of ratio 3200/5A</p> <ul style="list-style-type: none"> • Core 1: Class 0.5 & 15VA burden – For MFM • Core 2: 5P20 & 15VA – For Ashida make O/C+E/F relay <p>b) 3 nos single core CTs of ratio 3200/5 A, Class 0.5 & 15 VA for Energy meter (Energy meter is not in bidder scope)</p> <p>c) 1 no single core CT of ratio 3200/5A, 5P20 & 15 VA for Neutral unbalance protection</p> <p>Approved Make of CTs: Reco/Newtek/Pragati/Kappa/ECS/Adcon</p>
	27	TTB for Metering	Front connection, Screw Type 3 Phase 4 Wire, 4SF, 50 A, DAV/IMP Make
	28	Wiring convention for TTB	Incoming from Bottom Side & Outgoing to Meter from Top side
	29	Multifunction Digital meter	Should be communicable on Modbus RS 485
	30	Earth Fault protection relay (NEF)	Alstom make CDG11 self-powered. Relay type is normal inverse with 3 Sec with E/F setting of 0.5 to 2 A
	31	Earthing Hardware	a) Earthing Nut and Bolt shall be M12 SS b) Washers shall be with Hot Dip Galvanized with 80 micron Galvanisation or Alu-Zinc coating.
	31a	Panel Earthing	Earthing provision to be provided on both sides with 50 mm extension of main Earth Bus Bar.
	32	Clearance between live parts	Phase - phase -Minimum 25 mm & Phase - earth - Minimum 20 mm
33	Distance between each fuse outlet	Centre to Centre - 150mm (Minimum)	

Rev No.	Prepared By & Date	Checked By & Date	Approved for Issue By & Date
R00	Yash M. Mane 	Ajay V. Potdar 	Ravindra M. Bhanage 
	11/01/2024	11/01/2024	11/01/2024

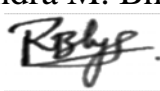

		34	Distance between fuse outlet & panel surface	125 mm (Minimum)
		35	Control terminals for CTs	Stud type with disconnecting facilities
		36	Control terminals for Voltage & other circuits	Stud type
		37	Illumination and Indicating Bulb	LED
		38	Continuous rated operating voltage	440 volt +/- 10%
		39	High voltage withstand capacity	2000 volt at 50 Hz for 1minute
		40	Insulation resistance ph-ph & ph-earth	Minimum 10MOhm with 500V Megger
		41	Labels & name plates	As per Specifications
		42	Surface preparation for painting	Sand blasting or 7 tank process
		43	Painting	Sand blasting or 7 tank process. Light grey shade No 631 of IS-5 Powder coated epoxy paint min thickness 120 micron
		44	Power Supply Socket	5A/15A Plug point socket to be provided
		45	Breaker Barrier	Breaker must have a metallic removable sheet from the front side which will act as a barrier between operator and the breaker. Provision must be given for breaker operation to be done through this barrier.
		46	Branding Plate	All supplied Units shall be fitted with engraved metallic logo of Tata Power on the front side. The Tata Power Co Ltd to be mentioned below the logo with clear font and Dimension 12*12 Inches. * Refer Annexure 2
		47	Panel Dimensions (Min depth of 900 mm)	L X D X H
		48	Numerical Relay	Ashida (ADR 241S) with 4 Element
		49	Bus-bar phase barriers/ Phase separators (R-Y & Y-B)	FRP insulating sheet - (to be placed near to the phase bus-bar) (min 3 mm thickness) shall be provided between bus-bars, so as to ensure that there is no accidental contact with any live parts. (65 mm width)

Rev No.	Prepared By & Date	Checked By & Date	Approved for Issue By & Date
R00	Yash M. Mane 	Ajay V. Potdar 	Ravindra M. Bhanage 
	11/01/2024	11/01/2024	11/01/2024



5.0

**GENERAL
CONSTRUCTION**

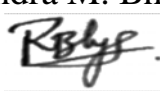
- 1) The feeder pillar frame shall be fabricated using suitable mild steel structural section or pressed and shaped Cold Rolled Closed Annealed (CRCA) sheet of thickness 3 mm.
- 2) Frames shall be enclosed by CRCA sheet of thickness 3mm, smoothly finished, levelled and free from flaws. Doors and cover shall be made of CRCA sheet of thickness not less than 2.5mm. Stiffeners shall be provided, wherever necessary. Gland plates shall be of Hot Rolled Closed Annealed (HRCA) thickness not less than 3 mm. alternatively gland can also be provided between two angles so that removal of gland is easy. The dimension of base frame should be 75mm X 40mm X 5 mm.
- 3) The panel shall be of metal enclosed and outdoor type, support frame mounted type with canopy of adequate slope to avoid water accumulation. Degree of protection shall be IP 54.
- 4) Breaker compartment and fuse compartment should be separated by metallic sheet; the same should be split suitably in order to avoid local heating due to eddy currents generated by three phase bus bars crossing through the same sheet. The breaker compartment should be in center of panel & Outgoings shall be on both the sides of breaker compartment.
- 5) The panel shall be of dust and vermin proof construction and of self-cooled design with adequate louvers on sides and top portion. The louvers shall have fine wire mesh made of brass. The minimum depth of panel shall be 900 mm.
- 6) Labels on the front and rear indicating the panel designation, phase marking and danger signs shall be provided. Single Line Diagram & feeder details shall be engraved and pasted on inside of panel.
- 7) Danger boards shall be provided in local languages on the Hylam sheet below breaker and on front & rear cover with red background and with white letters.
- 8) Hinged doors of lift off type, with concealed type with brass type hinges and captive screws shall be provided on the front side & Back side. Adequate numbers of door hinges shall be provided and should be durable and easy in operation. All doors shall be provided with padlocking facility. The design of doors should permit inter-changeability. The back-side doors shall have nut and bolt arrangement. All Hinged doors shall be connected to the earth terminal with 2.5 Sq.mm braided copper wires.
- 9) Cable entry facilities at bottom of panel and removable gland plates of size suitable to accommodate incoming & outgoing cables of sizes, 4 Core 300 Sq mm 1.1 KV XLPE Cable, shall be provided at required locations.
- 10) Distance between Gland plate and cable termination of Air Circuit Breaker should be minimum 600mm.
- 11) The panel shall be provided with gasket all around the perimeter of covers, gland plates, removable covers and doors.
- 12) ACB termination shall be with tinned copper or tinned aluminium Bus Bar. Wherever required bimetallic washer to be provide, if bare copper terminal is provided.

Rev No.	Prepared By & Date	Checked By & Date	Approved for Issue By & Date
R00	Yash M. Mane 	Ajay V. Potdar 	Ravindra M. Bhanage 
	11/01/2024	11/01/2024	11/01/2024

- 13) Busbars shall be of aluminium with Bakelite shrouding, rated for 3200 A, 50 kA for 1 sec and shall have adequate cross section to carry the rated continuous and short time current. Main Bus bar should be continuous/ without any joint. All bus bars, bus taps and joints shall be PVC taped. Neutral bus bar shall be provided on read side & rated for full bus bar rating.
- 14) The ACBs shall be mechanical operated fixed type 3 Pole with shunt trip coil without any microprocessor protection release. Ashida make (ADR41S) relay to be provided for tripping the breaker with Overcurrent & earth fault protection. Spare ACB contacts for shunt trip should be provided.**
- 15) All fuses shall be of the HRC cartridge type mounted on plug-in type fuse bases having a prospective current of not less than 80 kA.
- 16) Phase to phase clearance of 25mm and Phase to Neutral / Earth clearance of 20mm shall be provided in the panel.
- 17) Distance between centre to centre should be minimum 150mm between each fuse outlet and 125mm between fuse outlet and body of panel to be maintained.
- 18) The panel shall be provided with two separate earthing terminals connected to earth bus.
- 19) All instruments shall be connected to the earth terminal using 650V grade PVC insulated 2.5 sq mm stranded tinned copper earthing conductor. All Earthing should be routed properly along with body of panel.
- 20) All hinged doors, Covers, Gland Plates shall be connected to the earth terminal, with the help of braided copper conductors of adequate size. Flat earth bus should be protruded out for connection of external earth
- 21) Eyebolt of suitable sizes shall be provided for lifting arrangements.
- 22) All wiring shall be carried out with 650V grade PVC insulated stranded copper conductors of adequate sizes to suit the rated circuit current.
- 23) The panel shall be powder coated with light shade grade no 631 of IS 5.
- 24) Required number of foundation bolts shall be supplied with the panel.
- 25) Control fuses with control terminals for external cable connections shall be in the breaker chamber only.
- 26) The control terminals shall be as follows:
Stud type with disconnecting facilities for CT circuits
Stud type for voltage and other circuits.
- 27) Fuse bases shall have adequate contact surface with the bus bars provided to ensure that no local heating takes place.
- 28) Lighting System in Feeder Pillar should be LED based.

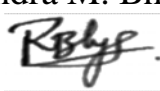
Rev No.	Prepared By & Date	Checked By & Date	Approved for Issue By & Date
R00	Yash M. Mane 	Ajay V. Potdar 	Ravindra M. Bhanage 
	11/01/2024	11/01/2024	11/01/2024

8 Way LT Panel: Representative GA drawing & SLD-

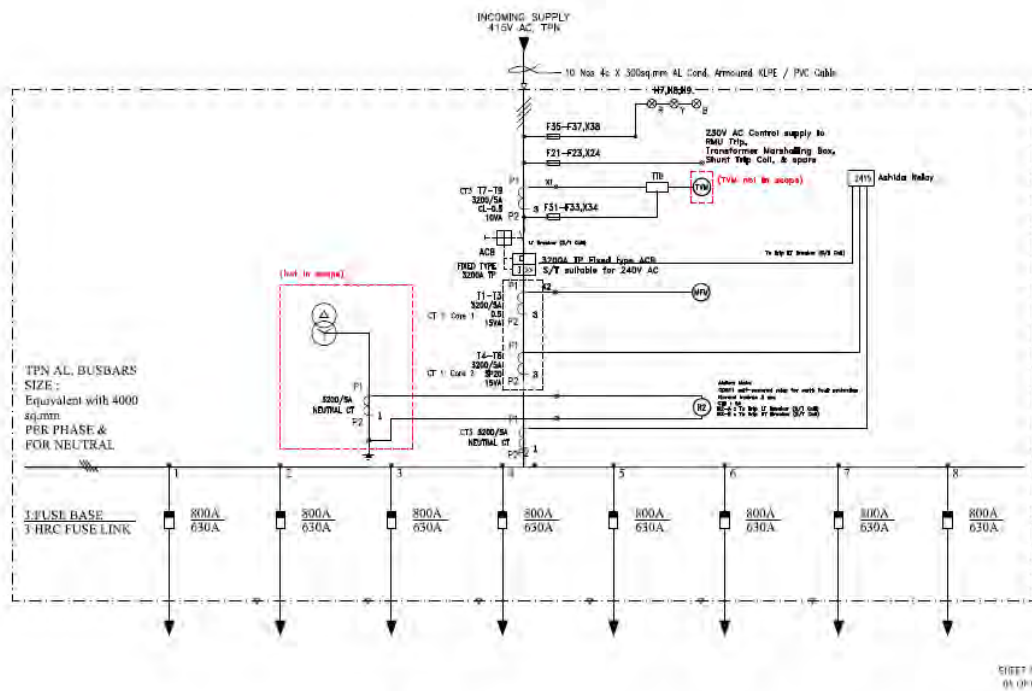
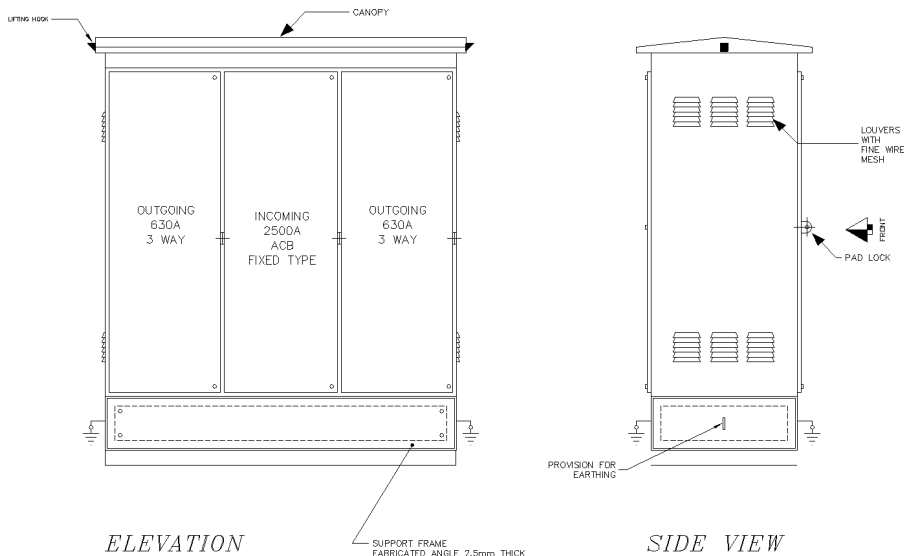

Rev No.	Prepared By & Date	Checked By & Date	Approved for Issue By & Date
R00	Yash M. Mane 	Ajay V. Potdar 	Ravindra M. Bhanage
	11/01/2024	11/01/2024	11/01/2024

8 Way Control Wiring Diagram:

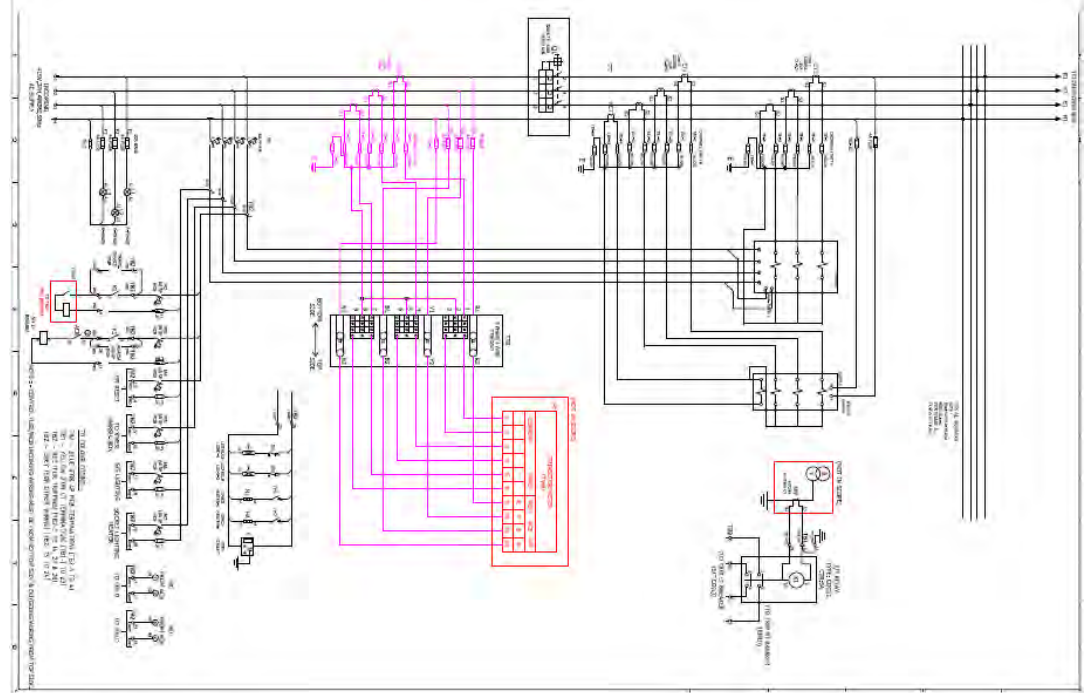



5.1

Specific Requirements

- a) The LT Panel should be 8 way type having 8 Nos. outlets per phase respectively as per tender requirement.
- b) Material Quality Plan, general arrangement drawing and single line diagram of the feeder pillar to be approved before manufacturing.
- c) Adequate cable termination shall be provided as follows

Sr. No.	TYPE	UoM	No. of Cable	Description
1	3200A Incomers	1No.	10	1.1KV, 4C, 300 sqmm AL cond. Armoured XLPE/PVC Cable
2	8 Way Panel 630 A Fuse Outgoing	8 no. Per outgoing	2	1.1KV, 4C, 300 sqmm AL cond. Armoured XLPE/PVC Cable

- d) 3200A Incomer shall be provided with resin cast CTs of ratio 3200/5A for metering & protection.
 3 nos dual core CT 3200A/5A, Core 1: 0.5 CI, Core 2: 5P20, 15 VA, to be used for MFM.
 3 nos single core CT 3200A/5A, 0.5, 15 VA, to be used for Energy metering.
 1 no single core CT 3200A/5A, 5P20, 15 VA, to be used for neutral unbalance protection.

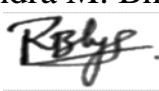
Rev No.	Prepared By & Date	Checked By & Date	Approved for Issue By & Date
R00	Yash M. Mane 	Ajay V. Potdar 	Ravindra M. Bhanage 
	11/01/2024	11/01/2024	11/01/2024

- e) All CT termination should be round plug type. No CT shorting arrangement to be provided. (As per SLD)
- f) Secondary wiring shall be carried out with 1.1KV grade PVC insulated stranded copper conductor of 2.5 Sq. mm for CT circuits and 2.5 Sq. mm for PT and other circuits. All wires will be colour coded.

Sr. No.	Equipment	Color	Nomenclature of TBs	Types of TBs
1.	TBs of 4 Pole MCB Termination	Blue	TB2	Droppable
2.	TBs for CT Termination	Yellow	TB1	Droppable
3.	TBs for Tripping	Red	TB2	Droppable
4.	All others	Default	TB2	Normal

- g) The feeder pillar panel shall be provided with Alstom Make CDG11 self-powered relay for earth fault protection. The relay type is normal inverse with 3 sec with E/F setting of 0.5 to 2 A.
- h) Test terminal box for Energy Metering should be Front Connection, Screw Type (4SF), 50 A to be provided and the convention of the wiring in the TTB should be Incoming from the bottom side and outgoing to Meter from top side. There must not be any partition between Relay & metering box in LV compartment. It should be single door compartment. No lugs shall be provided for wires to meter, TTB, and Fuses (PT secondary). Sealing arrangement to be provided for Energy Meters. Inspection glass (Transparent Toughened Glass) to be provided for viewing of meter.
- i) All Protection/ control wiring must terminate in LV compartment.
- j) Provision to be provided for mounting the energy meter with max dimensions as L x B x D: 360 x 200 x 200 mm (Energy meter will be supplied by TPC). The relay and energy meter shall be installed in the breaker compartment with suitable partitions. The relays shall be supplied by the vendor.
- k) The LT panel shall be equipped with shrouded type anti condensation space heaters with thermostat, internal light with switch & 5A/15A metal clad general-purpose plug socket.
- l) The following separate control circuit 20A, 4 pole MCB duly wired up to terminal block for purchaser's use shall be provided before the circuit breaker in feeder pillars leading to following single pole MCB with neutral links (refer SLD):

Phase and neutral for 230V supply to RMU. (6A)

Phase and neutral for 230V supply to Transformer marshalling box. (6A)

Phase and neutral for external shunt trip coil (6A)



Phase and neutral for FPI reset (6A)

Separate 16A, DP MCB duly wired for Auxiliary supply for LT panel for following purpose,

Phase and neutral for substation lighting (6A)

Phase and neutral for Socket (15A)/ Heater circuit

Phase and neutral for Ashida overcurrent relay (4A)

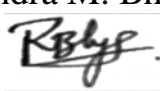
Rev No.	Prepared By & Date	Checked By & Date	Approved for Issue By & Date
R00	Yash M. Mane 	Ajay V. Potdar 	Ravindra M. Bhanage 
	11/01/2024	11/01/2024	11/01/2024

m) The following separate control fuses with neutral links duly wired out to a set of stud type link terminals for purchaser's use shall be provided before the circuit breaker in feeder pillars Control fuse Incoming wiring must be from bottom side & Outgoing wiring from top side. (refer SLD):

Three phase and neutral for metering circuit.

Three Phase and neutral for indication lamp

n) Locking should be of welded type. Earthing jumpers to be provided for all the doors. Louvers with stainless steel wire mesh to be provided on body side and cover plate.

o) Makes of various bought out items shall be limited to the following:

Sr. No.	Items	Approved Make
1	ACB	Schneider/ L&T/ Siemens/ C&S/ ABB/ Eaton
2.	CT	Reco/Newtek/Pragati/Kappa/ECS/Adcon

p) Flexible copper braiding should be provided on the doors. Neutral bus shall be connected with earth bus. All control cable should be multi stranded and FRLS. CT ISF should be less than or equal to 5. Close and Open status of the breaker should be available on SCADA through spare auxiliary contact and on LT panel through LED Lamp.



q) The fuses provide should be of knife type and same should be removable with the help of fuse puller. There shall be no obstruction during removal of outgoing fuses by fuse puller.

r) The safety locking facility to be provided for putting three nos. of safety locks.

s) Panel minimum width in mm: 900 mm

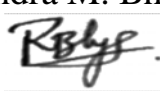

t) The breaker manufacturer to provide the complete support in terms of training; hand holding to our Testing and O&M staff. The breaker manufacturer to give the support service for next 10 years.

u) The robust isolating arrangement in the OG fuse compartment to be made as per the

Rev No.	Prepared By & Date	Checked By & Date	Approved for Issue By & Date
R00	Yash M. Mane 	Ajay V. Potdar 	Ravindra M. Bhanage 
	11/01/2024	11/01/2024	11/01/2024

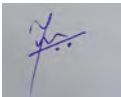

The Tata Power Company Limited		TECHNICAL SPECIFICATION OF 8 Way 3200 A LT Panel
ENSE-DS-2033-R00		Date of Issue: 11/01/2024

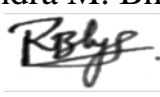
6.0	NAME PLATE AND MARKING	<p>6.1 Name plate- On front door top left side-showing</p> <ol style="list-style-type: none"> 1) Purchaser name & PO number. 2) Manufacturer name 3) Month / year of manufacturing 4) 'Property of Tata Power' <p>6.2 Marking for panel earth stud- Black letter 'E', on riveted Al label</p> <p>6.3 Danger board in English & local language, riveted on doors- White colour background with red lettering on 1.6mm thick Al plate.</p> <p>6.4 SLD shall be engraved & pasted on inside of door.</p> <p>6.5 CT Serial Nos., Ratio & ACB Serial Nos. to be written on doors with marker pen.</p> <p>6.6 Separate metallic name plate with Tata Power Logo of Dimension 12*12 Inches in clear font as shown in Annexure-2.</p>
7.0	TESTS	<p>All routine, acceptance & type tests shall be carried out in accordance with the relevant IS/IEC. Following tests shall be necessarily conducted on the 'Feeder Pillar' in addition to others specified in IS/IEC standards.</p> <p>*In case of any conflict on any technical particular, the stricter requirement mentioned in the relevant standard shall be valid.</p>
7.1	Type test	<p>Type test - Only type tested components – ACBs, Fuses, Insulators & aluminium bus bar shall be accepted. Following type test shall be carried out on the assembly.</p> <ol style="list-style-type: none"> a) Verification of temperature-rise limits – Clause 8.2.1 of IS 8623 b) Verification of dielectric properties – Clause 8.2.2 of IS 8623 c) Verification of short-circuits strength – Clause 8.2.3 of IS 8623 d) Verification of continuity of the protective circuit – Clause 8.2.4 of IS 8623 e) Verification of clearance and creepage distances – Clause 8.2.5 of IS 8623 f) Verification of mechanical operation – Clause 8.2.6 of IS 8623 f) Verification of degree of protection – Clause 8.2.7 of IS 8623
7.2	Routine test	<p>Acceptance & routine test- (Inspection test witness by purchaser as per approved Quality Assurance Plan)</p> <ol style="list-style-type: none"> 1) Visual inspection, dimension checks & paint thickness checks. 2) Bill of material check 3) Insulation resistance test 4) High voltage test 5) Operational check 6) Verification of dielectric properties 7) Tolerances on panel dimensions- Maximum +/- 5mm 8) No negative tolerance on bus bar dimensions & bus bar clearances 9) Stability test shall be conducted on all Panels, to ensure there shall be no tripping in case of unbalance current on earth fault function.

Rev No.	Prepared By & Date	Checked By & Date	Approved for Issue By & Date
R00	Yash M. Mane 	Ajay V. Potdar 	Ravindra M. Bhanage 
	11/01/2024	11/01/2024	11/01/2024

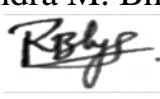

The Tata Power Company Limited		TECHNICAL SPECIFICATION OF 8 Way 3200 A LT Panel
ENSE-DS-2033-R00		Date of Issue: 11/01/2024

7.3	Acceptance test	<ol style="list-style-type: none"> 1) Visual inspection & dimensional check 2) Verification of clearance and creepage distance 3) Paint thickness check 4) Wiring checks 5) Insulation resistance test 6) HV test 7) Stability test on all Panels, to ensure there shall be no tripping in case of unbalance current on earth fault function. 8) 1 unit from 1st lot shall be tested for Temperature rise test with ACB and fuses. (Bidder to arrange for the same, either in factory or in external lab)
8.0	TYPE TEST CERTIFICATE	<p>The Bidder shall furnish the type test certificates for the tests as mentioned above as per the corresponding standards. Type Test to be conducted on similar Design/ rating panel. All the tests shall be conducted at CPRI / ERDA/ NABL as per the relevant standards. Type test should have been conducted in certified Test Laboratories during the period not exceeding 10 years from the date of opening the bid.</p> <p>Type tests shall have been conducted in certified Test laboratories during the period not exceeding 10 years from the date of opening the bid. In case if type test conducted beyond 10 years then bidder to certify on letter head of parent OEM that no design change & no manufacturing plant change occurred from type tested product.</p> <p>In the event of any discrepancy in the test reports, i.e. any test report not acceptable or any/all type tests (including additional type tests, if any) not carried out, same shall be carried out without any cost implication to TATA POWER.</p>
9.0	PRE-DISPATCH INSPECTION	<p>The Material shall be subject to inspection by a duly authorized representative of the TATA POWER COMPANY. Inspection may be made at any stage of manufacture at the discretion of the Purchaser and the equipment, if found unsatisfactory as to workmanship or material, the same is liable to rejection. Bidder shall always grant free access to the places of manufacture to TATA POWER COMPANY `s representatives when the work is in progress. Inspection by the TATA POWER COMPANY or its authorized representatives shall not relieve the Bidder of his obligation of furnishing equipment in accordance with the specifications. TATA POWER COMPANY authorized representatives shall have the right to inspect the design, materials and workmanship and to report thereon, at any stage of manufacture, if found necessary. All facilities shall be extended to our representatives for witnessing the tests. Due notice shall be given to us to enable us to depute our representatives for stage inspection.</p> <p>Material shall be dispatched after specific MDCC (Material Dispatch Clearance Certificate) is issued by TATA POWER COMPANY.</p> <p>Five certified copies of all test certificates including type tests, sample test certificates shall be sent to us for our approval prior to dispatch of materials.</p> <p>Following documents shall be sent along with material</p> <ol style="list-style-type: none"> a) Test reports b) MDCC issued by TATA POWER COMPANY c) Invoice in duplicate d) Packing list e) Drawings & catalogue f) Delivery Challan g) Other Documents (as applicable).

Rev No.	Prepared By & Date	Checked By & Date	Approved for Issue By & Date
R00	Yash M. Mane 	Ajay V. Potdar 	Ravindra M. Bhanage 
	11/01/2024	11/01/2024	11/01/2024

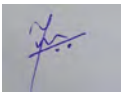

The Tata Power Company Limited		TECHNICAL SPECIFICATION OF 8 Way 3200 A LT Panel
ENSE-DS-2033-R00		Date of Issue: 11/01/2024

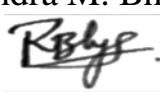
10.0	INSPECTION AFTER RECEIPT AT STORE	<p>The material received at TPC, Mumbai store shall be inspected for acceptance and shall be liable for rejection, if found different from the reports of the pre-dispatch inspection or any other parameters observed after delivery.</p> <p>The material should be delivered at TPC, Mumbai stores within 45 days from the date of manufacturing, same shall be checked during delivery and overdue material shall not be accepted. Bidders to plan the delivery accordingly.</p> <p>Bidders to attend and rectify the same at his own cost. The material shall be accepted in stores only after rectification of any observed flaw. The delay in rectification shall lead to any contractual penalty.</p> <p>Billing shall be processed only after acceptance of the material.</p>
11.0	GUARANTEE	<p>Bidder shall stand guarantee towards design, materials, workmanship & quality of process / manufacturing of items under this contract for due and intended performance of the same, as an integrated product delivered under this contract.</p> <p>In the event any defect is found by the TATA POWER COMPANY up to a period of at least 12 months from the date of commissioning or 24 months from the date of last supplies made under the contract whichever is later, (the time scale of 12/24 months could be enhanced subject to mutual agreements) Bidder shall be liable to undertake to replace/rectify such defects at its own costs, within mutually agreed time frame, and to the entire satisfaction of the Purchaser, failing which the TATA POWER COMPANY will be at liberty to get it replaced/rectified at Bidder's risks and costs and recover all such expenses plus the Purchaser's own charges (@ 20% of expenses incurred), from the Bidder or from the " Security cum Performance Deposit" as the case may be.</p> <p>In case of GP failure, BA shall report at site within 48 hours from intimation and arrange for rectification of fault within a mutually agreed time. In case rectification at site is not possible then alternative arrangement (replacement) to be made by BA within 15 days of intimation of failure.</p> <p>Bidder shall further be responsible for 'free replacement' for another period of THREE years from the end of the guarantee period for any 'Latent Defects' if noticed and reported by the Purchaser.</p>
12.0	PACKING AND TRANSPORT	<p>Bidder shall ensure that the item covered under this specification shall be packaged for rail/road transport in a manner so as to protect the equipment from damage in transit.</p> <ol style="list-style-type: none"> 1) Packing protection- Against shocks, vibration & corrosion, damages during transportation 2) Packing identification labels, to show purchaser name, PO number, quantity of panels, Panel type, Manufacturer serial number 3) Handling instruction- To be marked on packing boxes. 4) Bidders should prefer to use recyclable & environmentally friendly materials for packing. 5) No single use plastic to be used. 6) Packing should be done with environment friendly recyclable materials.
13.0	TENDER SAMPLE	Not Applicable

Rev No.	Prepared By & Date	Checked By & Date	Approved for Issue By & Date
R00	Yash M. Mane 	Ajay V. Potdar 	Ravindra M. Bhanage 
	11/01/2024	11/01/2024	11/01/2024

The Tata Power Company Limited		TECHNICAL SPECIFICATION OF 8 Way 3200 A LT Panel
ENSE-DS-2033-R00		Date of Issue: 11/01/2024

14.0	QUALITY CONTROL	<p>The Bidder shall submit with the offer Quality assurance plan indicating the various stages of inspection, the tests and checks which will be carried out on the material of construction, components during manufacture and bought out items and fully assembled component and equipment after finishing. As part of the plan, a schedule for stage and final inspection within the parameters of the delivery schedule shall be furnished.</p> <p>TATA POWER COMPANY shall reserve the sole rights for the type test of a random sample from the lot and in case of any discrepancy or deviation from the Type test certificates submitted along with the Bid; the complete Lot shall be rejected.</p> <p>TATA POWER COMPANY representative or its nominated representative shall have free access to the Bidder's works to carry out inspections.</p> <p>If anything missing in QAP and required as per other clauses of this document, bidder is liable to perform the same without cost implication.</p>
15.0	MINIMUM TESTING FACILITIES	Bidder shall have adequate in-house testing facilities for carrying out all routine tests & acceptance tests as per relevant International / Indian standards and as specified above.
16.0	MANUFACTURING ACTIVITIES	The successful bidder will have to submit first GTP & Drawing with 7 days from placement of outline agreement for approval and complete the approval process within 14 days of outline agreement. The date of Code -2/ Code-1 approval given by TATA Power will be treated as first day for assessment of LD (if applicable).
17.0	SPARES, ACCESSORIES, AND TOOLS	Keys of door
18.0	DRAWING AND DOCUMENTS	<p>Following drawings and documents shall be prepared based on TATA POWER COMPANY specifications and statutory requirements and shall be submitted with the bid. All the documents & drawings shall be in English language</p> <ol style="list-style-type: none"> Completely filled in Technical Particulars General description of the equipment and all components including brochures. General arrangement drawing. Bill of material Experience List Type test certificates Any other technical document, if required
19.0	SCHEDULE "A" GUARANTEED TECHNICAL PARTICULARS	Bidders to comply for all above requirement of specifications clauses & submit signed and stamp copy as technical compliance document.

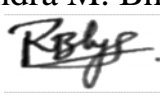
Rev No.	Prepared By & Date	Checked By & Date	Approved for Issue By & Date
R00	Yash M. Mane 	Ajay V. Potdar 	Ravindra M. Bhanage 
	11/01/2024	11/01/2024	11/01/2024

20.0

**SCHEDULE
"B" DEVIATIONS**

The bidders shall set out all deviations from this specification, Clause by Clause in this schedule. Unless specifically mentioned in this schedule, the tender shall be deemed to confirm the purchaser's specifications.

(TO BE ENCLOSED WITH THE BID)

All deviations from this specification shall be set out by the bidders, clause by Clause in this schedule. Unless specifically mentioned in this Schedule, the tender shall be deemed to confirm the purchaser's specifications:



Sr.No.	Clause No.	Details of deviation with justifications

We confirm that there are no deviations apart from those detailed above.

Seal of the Company

Signature :

Designation :

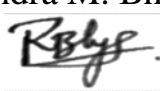
Rev No.	Prepared By & Date	Checked By & Date	Approved for Issue By & Date
R00	Yash M. Mane 	Ajay V. Potdar 	Ravindra M. Bhanage 
	11/01/2024	11/01/2024	11/01/2024



The Tata Power Company Limited		TECHNICAL SPECIFICATION OF 8 Way 3200 A LT Panel
ENSE-DS-2033-R00		Date of Issue: 11/01/2024

Annexure – 1

Inspection Testing Plan

1. Visual inspection & dimensional check
2. Verification of clearance and creepage distance
3. Paint thickness check
4. Wiring checks
5. Insulation resistance test
6. HV test
7. Stability test on all Panels, to ensure there shall be no tripping in case of unbalance current on earth fault function
8. 1 unit from 1st lot shall be tested for Temperature rise test with ACB and fuses. (Bidder to arrange for the same, either in factory or in external lab)

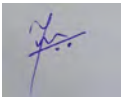
TATA POWER

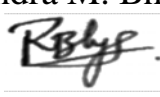
Rev No.	Prepared By & Date	Checked By & Date	Approved for Issue By & Date
R00	Yash M. Mane 	Ajay V. Potdar 	Ravindra M. Bhanage 
	11/01/2024	11/01/2024	11/01/2024

Annexure – 2

Tata power Branding Name plate -

Separate metallic name plate with Tata Power Logo of Dimension 12*12 Inches in clear font as shown below.

Relationship between the two marks- size

The Tata and Tata Power Marks are always used in conjunction with each other, never appearing in isolation on Tata Power communication.

The height of the letter T of Tata (T-height) is the basic measure for all sizes and proportions.

The rounded measure 2T in height, is separated from the Tata lettering by a distance of 1/2T.

The T height of both, the Tata and the Tata Power Marks is to be the same, except in exceptional cases on approval from the Corporate Communications team.





Relationship between the two marks- positioning

The two marks can appear stacked, which is the preferred placement, or linear, by the side of one another.

Centre aligned - Stacked (Preferred)

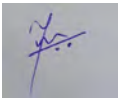

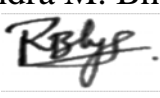

Rev No.	Prepared By & Date	Checked By & Date	Approved for Issue By & Date
R00	Yash M. Mane 	Ajay V. Potdar 	Ravindra M. Bhanage 
	11/01/2024	11/01/2024	11/01/2024

The Tata Power Company Limited		TECHNICAL SPECIFICATION OF 8 Way 3200 A LT Panel
ENSE-DS-2033-R00		Date of Issue: 11/01/2024

Annexure – 3

Reference drawings

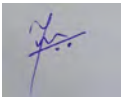
TATA POWER

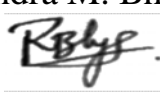
Rev No.	Prepared By & Date	Checked By & Date	Approved for Issue By & Date
R00	Yash M. Mane 	Ajay V. Potdar 	Ravindra M. Bhanage 
	11/01/2024	11/01/2024	11/01/2024

INCOMING SUPPLY
415V AC, TPN

10 Nos 4c X 300sq.mm AL Cond. Armoured XLPE / PVC Cable.

H7,H8,H9.

230V AC Control supply to
RMU Trip,
Transformer Marshalling Box,
Shunt Trip Coil, & spare

(TVM not in scope)

241S Ashida Relay

CT3 T7-T9
3200/5A
CL-0.5
10VA

LT Breaker (S/T Coil)

ACB
FIXED TYPE
3200A TP
3200A TP Fixed type ACB
S/T suitable for 240V AC

To Trip LT Breaker (S/T Coil)

(Not in scope)

T1-T3
3200/5A
CT 1: Core 1 0.5
15VA

T4-T6
3200/5A
CT 1: Core 2 5P20
15VA

Alstom Make
CDG11 self-powered relay for earth fault protection
Normal Inverse 3 sec
CTR : 5A
R2-A : To Trip LT Breaker (S/T Coil)
R2-B : To Trip HT Breaker (S/T Coil)

CT3 3200/5A
NEUTRAL CT

3200/5A
NEUTRAL CT

TPN AL. BUSBARS
SIZE :
Equivalent with 4000
sq.mm
PER PHASE &
FOR NEUTRAL

3:FUSE BASE
3:HRC FUSE LINK

800A
630A

800A
630A

800A
630A

800A
630A

800A
630A

800A
630A

800A
630A

800A
630A